

SOUTHERN CALIFORNIA WHOLESALE FOOD FACILITY CONSTRUCTION GUIDE

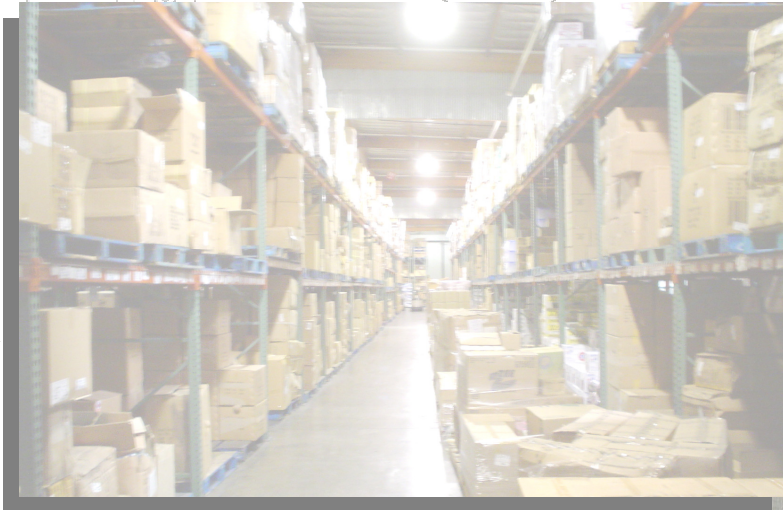

A collaborative effort by the
Regional Wholesale Food Processors Committee

CONTACT INFORMATION

Los Angeles County Environmental Health Division
Plan Check Section
5050 Commerce Drive
Baldwin Park, CA
(626) 430-5200

Orange County Environmental Health
1241 E. Dyer Rd., Suite 120
Santa Ana, CA 92705
(714) 433-6000

San Bernardino County Environmental Health
Wholesale Department
1647 E. Holt Blvd.
Ontario, CA
(909) 458-9673

San Diego County Environmental Health
1255 Imperial Ave., 3rd Floor
San Diego, CA 92101
(619) 338-2064

City of Vernon
Environmental Health and Control
4305 S. Santa Fe Ave.
Vernon, Ca 90058
(323) 583-8811 Ext. 288

USDA (New Facility Information)
620 Central Ave.
Alameda, CA 94501
(510) 337-5000

California Department of Food and Agriculture
2403 W. Washington St., Room 10
Stockton, CA 95203
(209) 466-7168

GUIDELINES FOR CONSTRUCTION OF WHOLESALE DISTRIBUTION, FOOD PROCESSING ESTABLISHMENTS

This Plan Check Guide is a product of the Regional Wholesale Food Processors Committee (RWFPC), a collaborative partnership between the Food Industry Business Roundtable (FIBR) and the Environmental Health Departments of Los Angeles, Orange, San Bernardino and San Diego Counties and the City of Vernon. The RWFPC is an effort to expand communications and services among the food industry and regulatory agencies of Southern California.

It must be emphasized that this document is strictly a guideline and must not be interpreted as code requirements. This document suggests best construction practices that are hopefully adopted by builders and developers.

Wholesale food facilities are businesses that receive, store, handle, process and distribute food items to retail facilities. Generally, wholesale food facilities do not conduct retail sales, or distribution. Wholesale food facilities include dry and cold storage warehouses that do not handle open food products. Wholesale food facilities also include commercial food processing facilities that are subject to inspections by federal and state agencies

The Food and Drug Branch of the California Department of Health Services is the administrative authority for wholesale food facilities in the State of California. However, under the Food Sanitation Act, four local jurisdictions are given authority to regulate and conduct inspections at wholesale food facility inspections. These jurisdictions include the environmental health departments from Los Angeles County, Orange County, San Bernardino County and City of Vernon. In addition, San Diego County recently enacted a local ordinance that allows their Environmental Health Section to oversee wholesale food distribution facilities.

Although the Food and Drug Branch of the California Department of Health Services has general requirements of wholesale food facilities, it does not require a plan approval prior to construction of food facilities. Similarly, federal agencies such as the Food and Drug Administration (FDA) and United States Department of Agriculture also have requirements of these facilities but they too do not have an active plan review requirement. These agencies only conduct inspections and approve the constructed facilities prior to use. However, the local environmental health departments of Los Angeles, Orange County, San Bernardino County, San Diego County, and the city of Vernon do require the submittal and approval of construction plans prior to the construction or remodel of any wholesale food facility. The information contained in this document can be used as a guideline, however, each of the local agencies indicated above do have specific requirements and should be contacted for plan approval before beginning construction.

The main goal of this document is to provide industry with a uniform document that contains reasonable and compliant standards for the construction or renovation of wholesale food facilities. Again it must be emphasized that this document is strictly a guide. Some jurisdictions and their regulations may or may not have statutory authority for the items stated in this document.

TABLE OF CONTENTS

APPROVAL FROM OTHER AGENCIES	5
PLAN SUBMISSION	5
PRODUCT FLOW	6
ROOM REQUIREMENTS	7
CONSTRUCTION REQUIREMENTS	7
FLOORS	7
ACCEPTABLE FLOOR COVERINGS	7
BASE COVING REQUIREMENTS	8
WALL AND CEILING	10
LIGHTING	11
VENTILATION	12
FLY, RODENT, AND OTHER PESTS EXCLUSIONS	14
LAVATORIES (HANDWASHING)	15
TOILET FACILITIES	15
DRESSING ROOMS	16
STORAGE REQUIREMENTS	16
GARBAGE AND TRASH AREAS	17
GENERAL PURPOSE WATER	17
CROSS CONNECTION CONTROLS	17
JANITORIAL FIXTURES	20
JANITORIAL EQUIPMENT	20
APROVED TYPE	21
SINKS	21
REFRIGERATION	22

ICE MACHINES	23
STORAGE EQUIPMENT	23
INSTALLATION REQUIREMENTS	23
EQUIPMENT	23
FLOOR DRAINS	24
FLOOR SINKS	24
CONDUITS	25
SPECIAL REQUIREMENTS	25
CROSS CONNECTION / BACKFLOW DEVICES	25
HAZARDOUS MATERIALS AND HAZARDOUS WASTE	25
STORM WATER PROTECTION	25
ONSITE SEWAGE DISPOSAL SYSTEMS – SEPTIC SYSTEM	26
ONSITE WATER WELLS / WATER SYSTEM	26
CONSTRUCTION INSPECTION	26
FINAL INSPECTION	26
BASIC REQUIREMENTS	28
APPENDIX	
ATTACHMENT I	Mechanical Exhaust Ventilation Systems
ATTACHEMENT II	Guidelines for Sizing Water Heaters
ATTACHMENT III	Safe Plumbing Practices
SUPPLEMENTAL INFORMATION	
What You Need To Know About Registration of Food Facilities	
Interim Guidance for Food and Agriculture Safety in California	
Guidance for Food Safety During Power Outages	
Guidance for Foods Exposed to Ammonia Leaks in Cold Storage Facilities	

APPROVAL FROM OTHER AGENCIES

The type of product being produced, manufactured or used for wholesale purposes determines the federal and state agency that maybe involve in the construction and operational aspects of the plants. Local agencies are typically involved in most of the plan review of these facilities and may or may not be involved in the routine inspections of these plants.

For instance, a facility in Los Angeles County that intends to manufacture poultry items must contact the USDA Regional office for approval of their operations. Prior to construction of the same plant, the facility must submit plans for review and approval to Los Angeles County Environmental Health Department.

In another instance, a company in the City of Vernon that intends to construct a produce warehouse with refrigeration systems must submit plans to the Vernon Environmental Health Department for review and approval. This facility is also required to obtain a health permit from the city and is subject to routine inspections. Although these warehouses also require permits from the State of California Department of Health Services, they are not required to submit plans to this agency prior to construction.

In some instances, large cold storage facilities utilize ammonia refrigeration. Liquid ammonia is considered as an acutely hazardous material and is subject to inspection and permitting by the local Certified Unified Program Agency or CUPA. Local Cups are designated local jurisdictions that oversee and permit facilities that store, handle or dispose of hazardous materials or wastes.

Other hazardous materials typically found in food warehouse and processing facilities include propane, compressed gas such as oxygen, carbon dioxide and liquid nitrogen, sanitizers and floor cleaners. Facilities that store more than 55 gallons of these materials may be subject to local CUPA permitting and inspections.

PLAN SUBMISSION

Before constructing, enlarging, altering, or converting any building, room, or area for use for food processing or storage, three (3) sets of complete plans must be submitted to the appropriate local environmental health department. Most environmental health jurisdictions will require a fee for the review and approval of the plans. Depending on the work to be done, separate Building, Electrical, Plumbing, Mechanical, and Fire Construction Permits may be required.

Plans shall be drawn to scale and include a complete floor plan with plumbing, electric and equipment details. In addition, a finish schedule for floors, walls and ceilings indicating the type of material, finish, color and type of coved base at the floor-wall juncture (see attached) shall be provided. Brand names with specific product numbers as well as samples of materials may be requested to ensure acceptability.

The following information is a guide only and is not intended to cover every situation that may arise. Some facilities may have additional requirements.

Some jurisdictions can now accept electronic plans via the internet. We recommend plans to be submitted in an AutoCAD format (DWF, DWG, .DXF) or in a .PDF format. A digital copy of the file, on a CD, showing all the corrections must be submitted to this office prior to final approval of the project.

PRODUCT FLOW

An analysis of the physical flow of raw materials, food processing steps and finished products in the plant is highly recommended. Cross contamination and allergen contamination of products are food safety threats that can be avoided with a well-designed facility and operations. Designers should consult with owners and plan checkers prior to officially submitting the plans. Hopefully, this can reduce the time required for review and approval of submitted plans.

SAMPLE PRODUCT FLOW - FOOD PROCESSING

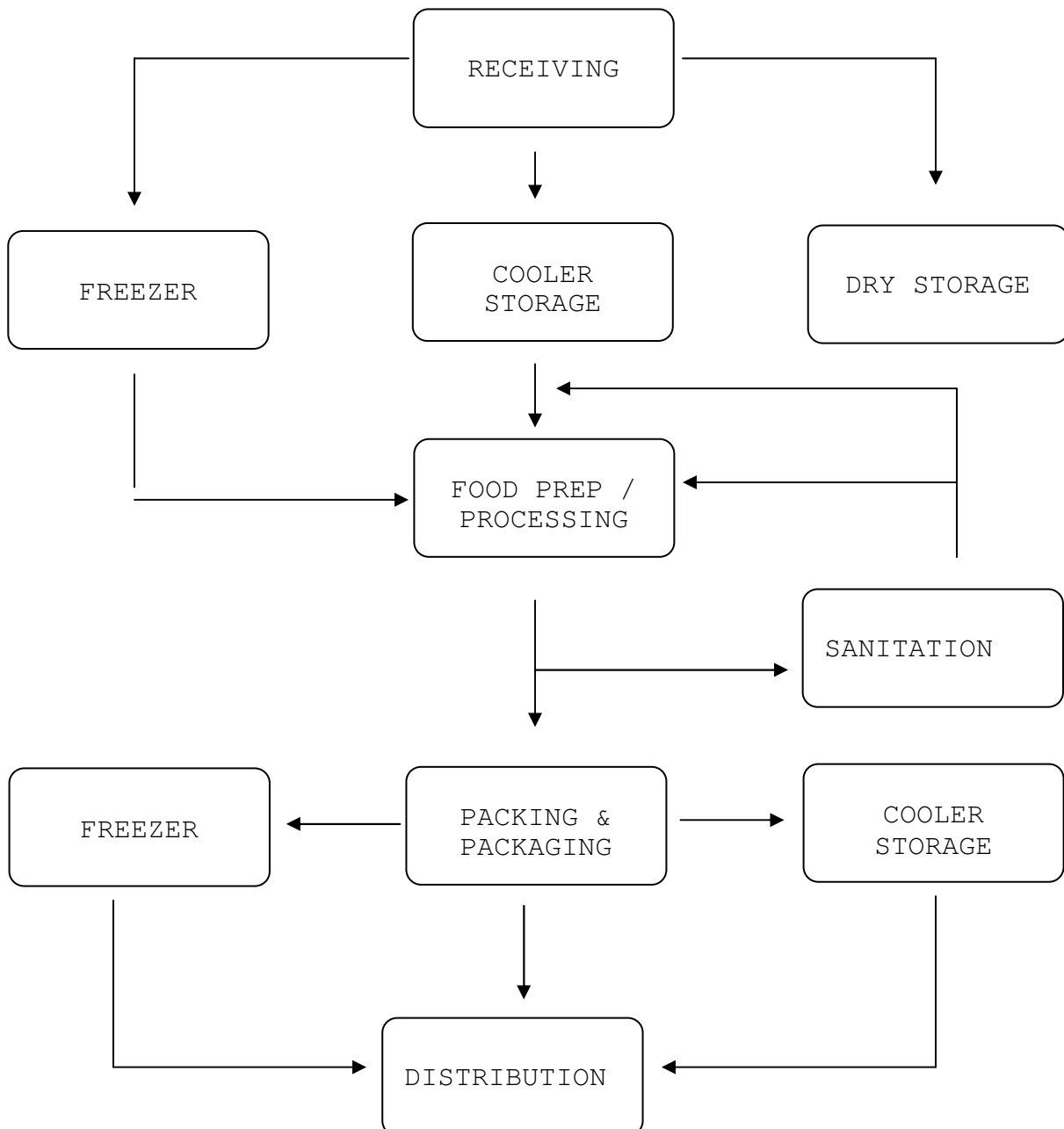

ROOM REQUIREMENTS

The following are typical rooms or areas which may be found or are required in a food processing facility:

1. Food processing room
2. Slaughter rooms
3. Male and female restrooms and locker rooms
4. Warehouse and storage rooms
5. Janitorial and sanitation rooms
6. Equipment and maintenance rooms
7. Dock areas
8. Shop areas
9. Office / Administrative rooms

Food processing, manufacturing and packing activities must be conducted in separate rooms with the requirements indicated in this document.

CONSTRUCTION REQUIREMENTS

The following are recommended elements that should be included in the construction of food facilities. Please note that most of these elements are required by state and local health ordinances, building and fire codes and federal recommendations.

I. FLOORS

The floor surfaces shall be of such construction and material so as to be smooth, impervious to water, grease, and acid, and easily cleanable in the following areas:

- Food or beverage preparation, processing or storage rooms or areas
- Slaughter rooms
- Walk-in refrigerators
- Utensil or equipment washing rooms
- Refuse or garbage storage rooms
- Restrooms, dressing rooms, and locker rooms

A. Acceptable Floor Covering Materials

The following flooring materials, when properly installed, are acceptable for use in retail food establishments:

1. Concrete
 - a. Concrete floors which are smooth, readily cleanable, and properly coved up the wall are acceptable if they have been sealed with a penetrating sealer which is clear, nonabsorbent, grease and acid resistant. All proposed sealers must be approved by the local health agency prior to application.

- b. Concrete floors which have been damaged, cracked, excessively worn, or that have been sawcut and repoured are required to be covered with an approved flooring material.
- c. The top of a concrete coved base shall be rounded off or sloped as shown in Figures 1 and 2.
- d. Troweled-on Seamless Resin Based Materials - The troweled-on resin based flooring shall be installed with a uniform thickness of at least 1/8 of an inch. Resin based materials which are rolled, brushed, or sprayed-on are not acceptable.
- e. A metal cap shall be installed at the top of the coved base in order to provide a base which is thicker and more durable. Resin based materials that are feathered at the top of the base are prone to chipping.

2. Quarry and Ceramic Tiles

- a. The minimum thickness for quarry and ceramic tiles is 1/4 inch. All tiles, regardless of thickness, will be evaluated on the basis of their density and porosity.
- b. The tiles and grout must be impervious to water, grease, and acid.

3. Alternative Flooring

Other flooring materials may be approved upon submittal of samples. Specifications and samples of alternative flooring materials must be submitted prior to installation.

B. Base Coving Requirements

The floor covering in the following areas shall be continuously coved up the walls at least four (4) inches with a minimum 3/8-inch radius cove, which is smooth at the juncture of the floor and wall (See Figures 1 & 2).

- 1. All areas where unpackaged food products are prepared or stored.
- 2. All areas where utensils are washed or stored.
 - a. At janitorial facilities
 - b. At indoor refuse storage areas
 - c. In restrooms
 - d. In employee clothing change/storage rooms and designated areas

3. In addition, the floor covering shall cover up all exposed sides of equipment cabinet bases and equipment curbs.
4. The use of approved topset covered base complying with the following criteria is generally acceptable:
 - a. Topset "slimfoot" covered base is typically acceptable for use after review and approval of a sample by the local health agency. (See figure 1)
 - b. A metal covered base is acceptable on metal walls, such as behind cooking equipment and the internal and external surfaces of a walk-in refrigeration unit. Metal covered base is also acceptable on equipment which is designed to be sealed to the floor, such as large pizza ovens and roll-in baking ovens. The metal used for the covered base shall be the same material as the wall or equipment, such as an aluminum base on an aluminum wall. Metal base coving is NOT allowed in processing rooms where extensive power washing or wash down activities are conducted.

Typical Base Coving

Not to scale

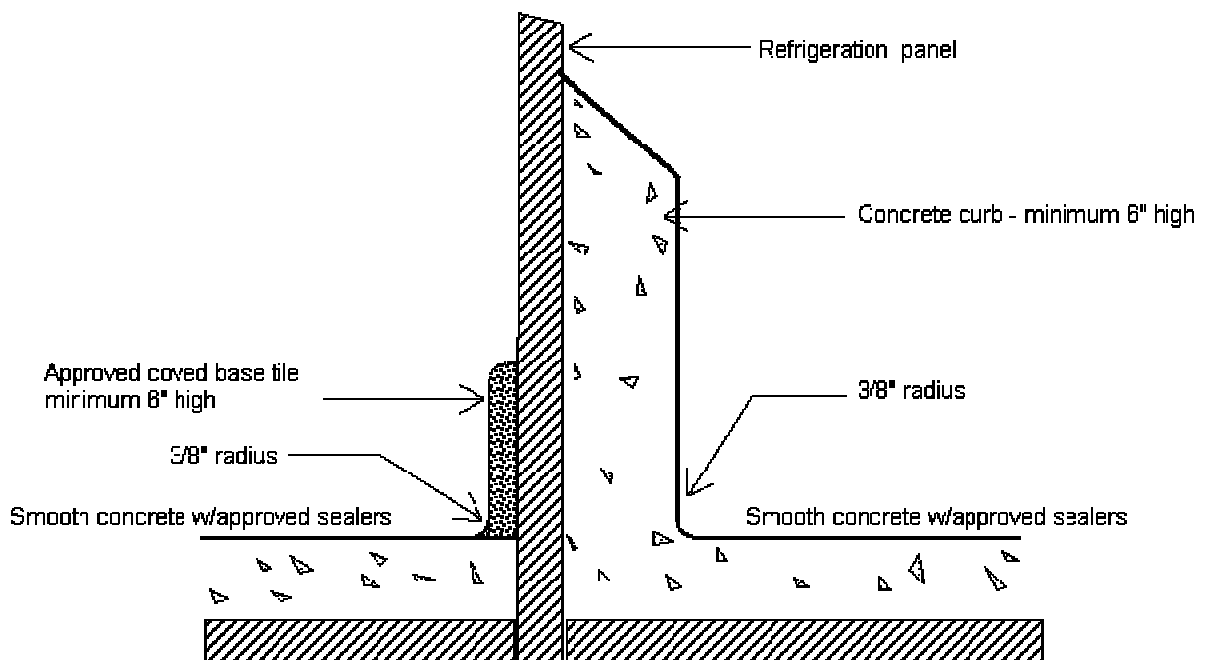
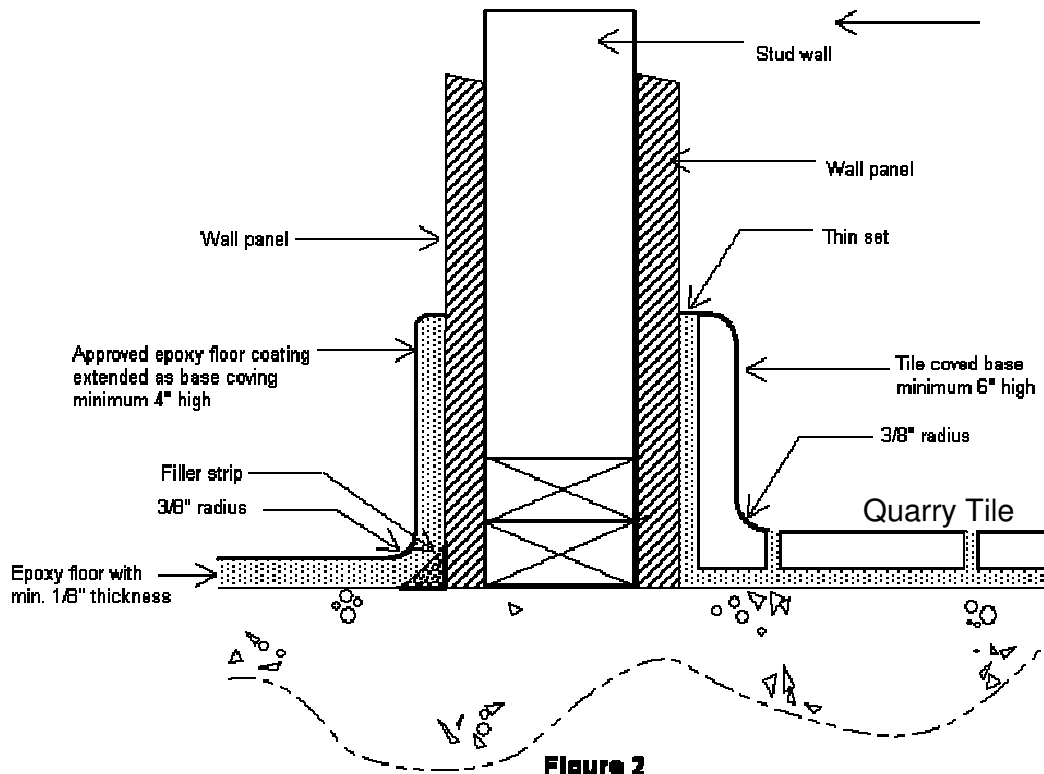

Figure 1



II. WALL AND CEILING CONSTRUCTION

- A. The under wall paneling shall be tightly butted together and to the floor and ceiling.
- B. The seams between drywall panels shall be properly taped to finish prior to painting.
- C. Wall paneling, such as FRP, shall be securely attached to the under wall surfaces so as to eliminate any bowing or buckling.
- D. Plumbing, gas, electrical and ventilation conduits shall be installed within walls and ceilings as practicable. When an in-wall installation is not feasible, conduits shall be mounted or enclosed in a chase to facilitate cleaning.
- E. Where plumbing, gas, and electrical lines enter a wall or ceiling, the opening around the lines shall be tightly sealed. When foam is used to seal openings, the exposed foam shall be smooth and readily cleanable. Eschution plates shall be installed around sprinkler nozzles and similar piping protrusions.
- F. Due to the explosive nature of flour dust, it is highly recommended that acoustical ceiling panels installed above areas where baking flour is used shall not contain any perforations. The panels shall be sealed in place with silicone or other acceptable material.

G. ACCEPTABLE WALL AND CEILING FINISH

The following materials, when properly installed, are generally acceptable for use in areas of food establishments that are required to have smooth, durable and easily cleanable wall and ceiling finishes:

1. Drywall that is taped to finish and sealed.
2. Stainless steel or galvanized steel wall flashing.
3. FRP panels.
4. Hardboard with a baked enamel finish, such as marlite. (This type of wall or ceiling material is not acceptable in high moisture areas.)
5. Smooth putty coat plaster. A light orange peel texture may be acceptable after a sample has been evaluated and approved by the local health agency.
6. Glazed ceramic tiles.
7. Smooth finished concrete tilt-up slabs
8. Reefer Panels

III. LIGHTING:

Light intensities are crucial in food processing activities. Adequate lighting allows for a thorough visual examination of products during production and inspection. Food preparation, utensil/equipment washing, toilet, and dressing rooms in wholesale food establishments require at least twenty (20) foot candles of light measured 30 inches above the floor or at the work surfaces. Food and utensil storage rooms require at least five (10) foot candles of light, and twenty (20) foot-candles of light during clean up activities. The following are recommended lighting intensities for the typical rooms:

ROOM TYPE	LIGHTING LEVELS (foot-candles)
Food processing room	20
Food processing room on food preparation surface	50
Male and female restrooms and locker rooms	20
Warehouse and storage rooms	5 - 20
Janitorial and sanitation rooms	20
Equipment and maintenance rooms	20
Slaughter rooms	50

Lighting fixtures in food preparation and dishwashing areas shall be protected against breakage through the use of plastic shields, plastic sleeves with end caps, shatterproof bulbs and/or other approved devices.

IV. VENTILATION

Approved ventilation shall be provided throughout the establishment (including toilet rooms, and dressing rooms) to keep all areas reasonably free from excessive heat, steam, condensation, smoke, and vapor, and to provide reasonable comfort for all employees. Adequate mechanical exhaust ventilation hoods shall be installed above all heating or cooking equipment where heat, smoke, steam or vapors are released. Hoods with adequate exhaust fans are also required over areas where significantly large amounts of heat, steam and vapors are generated such as equipment steam cleaning rooms. Hoods shall extend at least six inches (6") horizontally beyond the equipment or conform to manufacturer's ventilation specifications.

Equipment such as ranges, griddles, ovens, deep fat fryers, tortilla ovens and similar equipment shall have an exhaust system. Adequate make-up air throughout the establishment shall be provided. All equipment, construction, and installation shall be in accordance with manufacturer's specifications, local building and safety requirements and the Uniform Mechanical Code.

Adequate exhaust ventilation should be installed in rooms designated as sanitation rooms. The use of high pressure hot water, steam and chemical sanitizers generally increases the ambient humidity in the rooms. The build up of moisture in rooms without adequate ventilation can create hazardous conditions such a mold growth and deterioration of certain metal surfaces.

Please refer to Attachment I for further information on ventilation specifications and calculations.

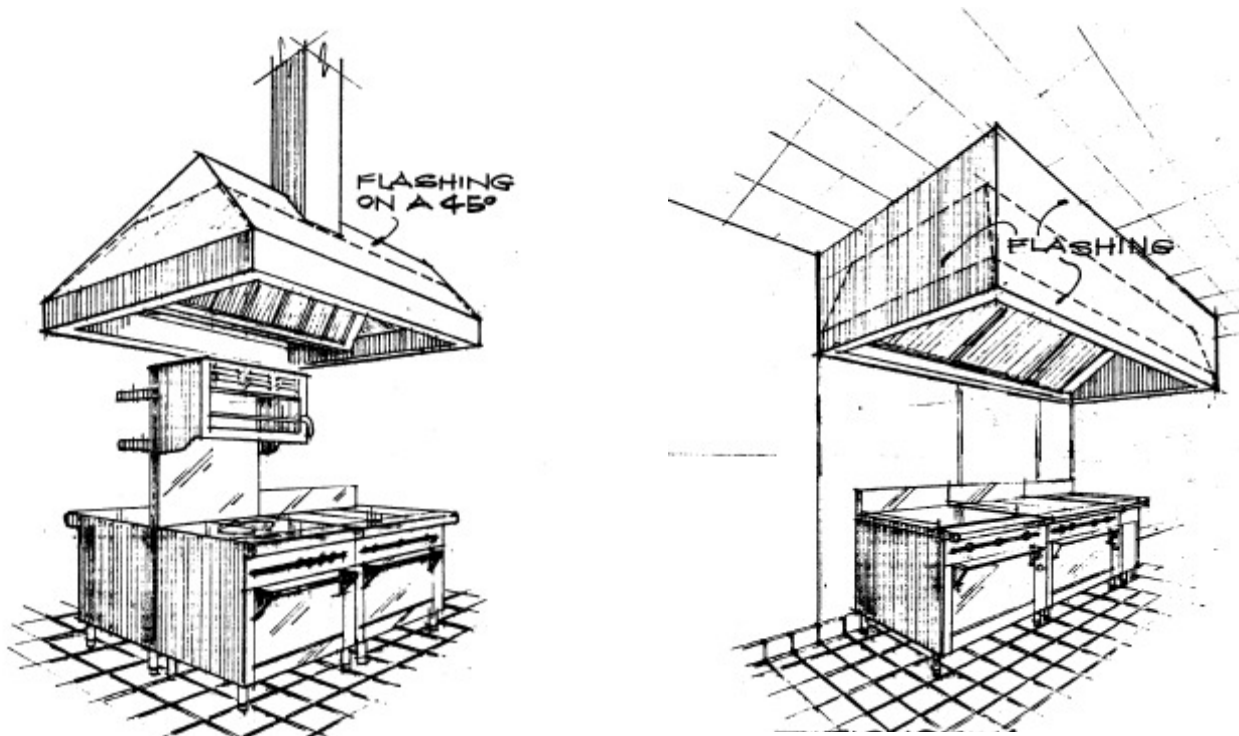

Canopy Hoods

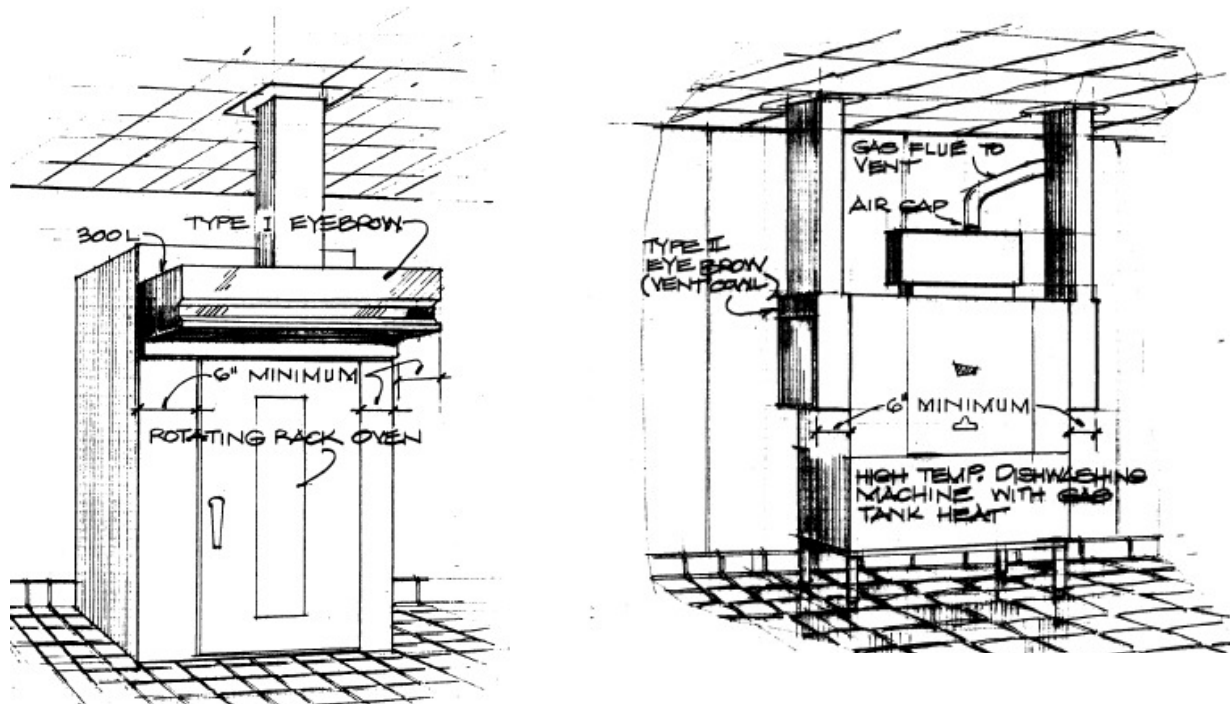

Eye brow Hoods

V. FLY, RODENT, AND OTHER PEST EXCLUSIONS AND CONTROL:

A. PEST EXCLUSION

1. Windows - Any openable window shall be provided with screening of no greater than fourteen (14) mesh. Openable windows to exterior areas in processing rooms are not approved.
2. Delivery Doors - All delivery doors leading to the outside from the processing room shall be provided with an effective fly exclusion device, e.g. air curtain.
LARGE CARGO-TYPE DOORS SHALL NOT OPEN DIRECTLY INTO A FOOD PROCESSING FROM THE OUTSIDE.

3. Entrance Doors: Approved doors are required at all entrances into the processing room, including entrances between the warehouse (storeroom), and the processing area. All doors shall be self-closing and/or may be equipped with an effective fly exclusion device, e.g. air curtain.

B. RODENT EXCLUSION

Openings at exterior doors (base and sides) shall be no greater than one-quarter inch (1/4"). All openings in exterior walls, including openings around pipes and other conduits are to be tightly sealed. All exterior wall vents shall be properly screened with one-quarter inch (1/4") wire mesh screen.

C. PEST CONTROL

A minimum of 18" aisle space between the wall and storage shelving or racks throughout the storage facilities provides an effective means of pest control prevention, inspection and cleaning.

The services of a reliable pest control company are highly recommended for wholesale food facilities. Regular inspections



and placement of the appropriate traps help prevent damaging rodent and Insect infestations in food production and storage facilities.

Destructive electronic fly zappers should not be placed directly over exposed food items and food preparation areas. The FDA (Food and Drug Administration) recommends the following:

1. Electronic Fly zappers shall be wall mounted only
2. Fly zappers shall be commercial grade
3. Electronic fly zapper shall be installed to no more than 3 feet above the floor and no less than 5 feet to any exposed food items.



Recent studies have revealed that electronic bug zappers are capable of spreading insect particles to up to six feet from the unit. Destructive electronic fly zappers are not recommended inside the processing rooms. Newer insect control devices include trapping systems which do not destroy the insects and do not spread the insect particles that may carry viruses and bacteria.

VI. LAVATORIES (HAND WASHING)

Employee hand wash lavatories shall be provided within or adjacent to toilet rooms. Hand washing facilities must also be located within the food processing rooms. Additional and easily accessible hand wash sinks help assure that hand washing practices are followed.

Hot and cold running water under pressure shall be provided through a mixing valve or combination faucet. The minimum hot water temperature for the facility is 120° F. Automated hand washers with integral hand sanitizers or infrared controlled faucets capable of dispensing at the minimum hot water temperature may be acceptable based on prior review and approval by the local health department. Faucets with spring operated shut-off mechanisms are not permitted. Hand washing detergent/soap and sanitary towels shall be provided in permanently installed commercial grade dispensing devices at all hand washing sinks.



VII. TOILET FACILITIES:

Separate toilet facilities for each sex are required if there are five or more employees per shift. For male restroom fixtures, one (1) urinal may substitute a every third toilet fixture. Toilet rooms shall be provided with an openable window or approved ventilation system. Toilet facilities shall not open directly into a food processing area. All doors leading to toilet facilities must be equipped with self-closing devices. The required number of toilets is dependant upon the number of employees. To calculate the number of employees, the calculation shall include managers and/or owners. For specific

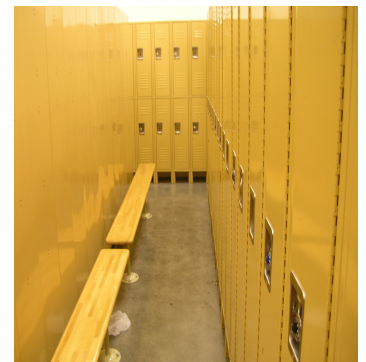

numbers and types of toilet facility fixtures, refer to the Uniform Plumbing Code.

VIII. DRESSING ROOMS:

A dressing room with a minimum of fifty (50) square feet of floor space, separate and apart from food preparation, food storage, and toilet rooms, is required where five or more employees of different sexes are on duty at any one time. If there are never more than five (5) employees on any shift, lockers or wardrobe closets are acceptable if provided and located in an area away from the food storage and processing.

IX. STORAGE REQUIREMENTS

In general, adequate warehouse and storage facilities shall be provided for the storage and distribution of food. Food items shall not be stored outside. Food processing facilities must have adequate storage facilities for both raw and finished materials. It is highly recommended that separate storage facilities must be provided for both raw and finished goods. All food shall be properly stored a minimum of six inches (6") above the ground on approved shelving. Pallets may be used in lieu of shelving if equipment is available to move the pallets on demand. Only one day's use of raw materials shall be permitted in the food preparation areas.

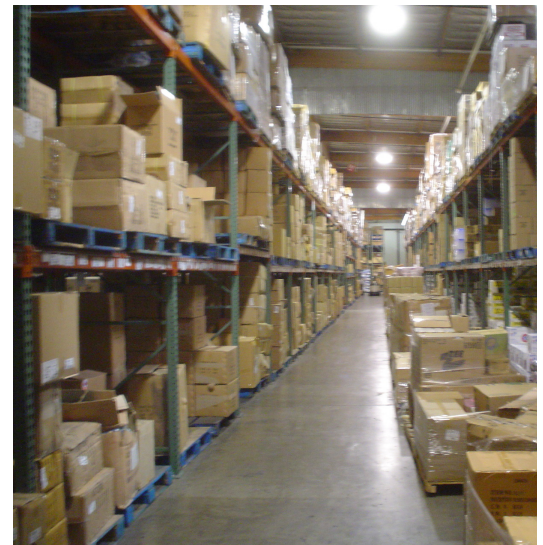

Storage shelving shall be of such construction and material as to be smooth and easily cleanable. Storage shelving inside the food processing portions of the plant and that are constantly subjected to wash down activities as part of the sanitation schedule must be of such material that is resistant to the corrosive effects of some sanitizers. Wooden shelving is not allowed in areas that are subjected to pressure wash downs.

In large warehouses, racking systems are typically installed. The bottom bar of the racking system must be at least 6" above the floor. Pallets may be used in lieu of the bottom rack if equipment is available to move the pallets on demand.

A public health critical factor in food warehousing and processing is the control of rodents. A minimum of 18" aisle space between the wall and storage shelving or racks throughout the storage facilities provides an effective means of pest control prevention, inspection and cleaning.

The design of the racks and the maximum height is regulated by the local fire code. The

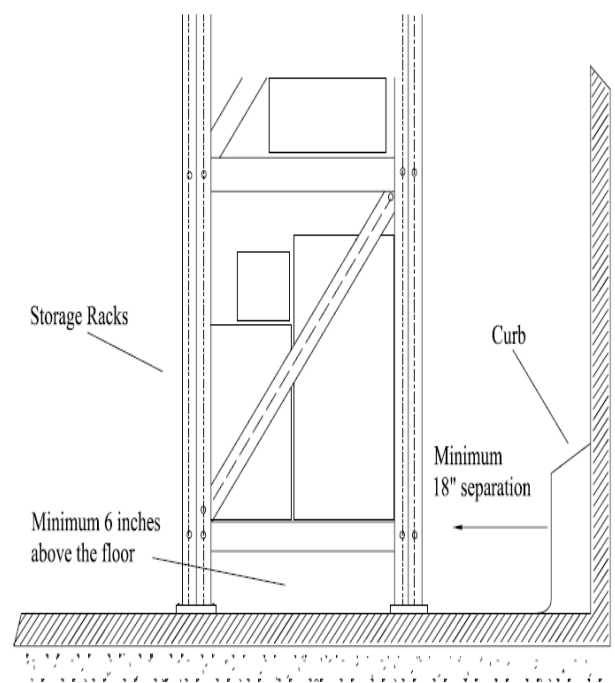

racking design for the facility must be approved by the local fire code inspector. For instance, non-sprinklered buildings cannot store general items more than eight feet in height. Storage rack heights must meet Uniform Fire Code sprinkler design requirements.

X. GARBAGE AND TRASH AREA:

Adequate trash containers for the plants must be provided. Trash container lids must be kept closed at all times. An area of adequate size for the proper storage of garbage and trash shall be provided for trash containers. The walls and floor of this area shall be constructed so as to be smooth, impervious to moisture and grease, easily cleanable, and light in color. Trash containers must be provided with fitting lids and must be reasonably leak proof.

Locations of proposed trash dumpster areas must have drainage from adjoining roofs and the pavement diverted around the areas. Location of proposed trash dumpster areas must have drainage from adjoining roofs and pavement diverted around the areas.

XI. GENERAL PURPOSE WATER:

All sinks are to be provided with hot water of at least 120° F and cold running water. Water heaters and or boilers must be adequately sized for the number of fixture units proposed in the facility. Please see *Attachment II* for information in sizing water heaters according to fixture units in the facility.

A. CROSS CONNECTION CONTROL

Approved backflow protection shall be provided for all faucets, hose bibs, wash down stations and industrial water use sites. Backflow devices are required when food or sanitation equipment are connected directly to a water supply line that concurrently supplies water to other sinks in the plant. Please see *Attachment III* for general cross connection principles.

B. EXAMPLES OF FACILITY EQUIPMENT THAT REQUIRE BACKFLOW DEVICES



Foaming Unit



Ozonator



Pressure / Chemical Washer



Chemical Mixing Unit



Foot Sanitizer Mixing Unit



Wash Station with chemical feed



In-line Sanitizer Supply

The following are the suggested backflow device type for typical uses and equipment found in food processing facilities:

Equipment or water use	Recommended devices
All hose bibs	Atmospheric Vacuum Breaker
Wash down faucets with fixed hose and spray nozzles	Pressure vacuum breaker
Wash down faucets without fixed hose connection	Atmospheric Vacuum Breaker
Assorted food processing equipment such as vacuum packing unit and product rinsing units	Atmospheric Vacuum Breaker or Pressure Vacuum Breaker
Boilers	Reduced Pressure Principle Device
Foot Sanitizer Dispensers	Pressure Vacuum Breakers
In line chemical dispensing units	Pressure Vacuum Breaker Or Reduced Pressure Principle Device
Ozonators	Reduced Pressure Principle Device

*** Please note the numerous pieces of equipment having built in backflow devices. These units must be evaluated by health department prior to determining if the built in device is adequate.*

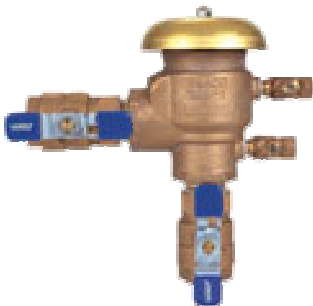

Pressure Vacuum Breaker

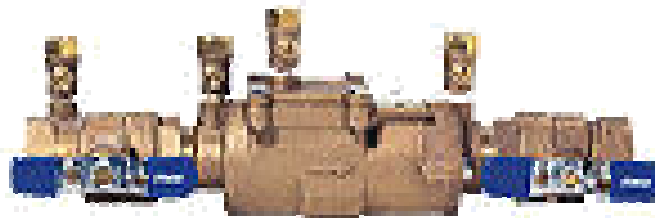

Double Check Valve



Atmospheric Vacuum Breaker

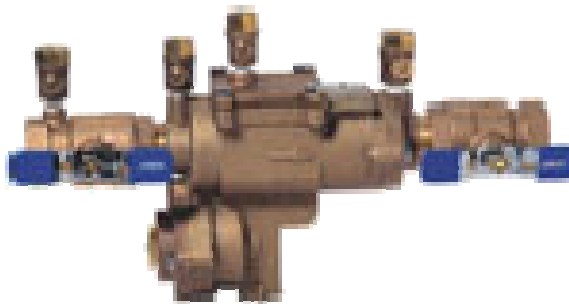

Reduced Pressure Principle Device

XII. JANITORIAL FACILITIES AND CLEANING CHEMICAL STORAGE ROOMS:

A room, area, or cabinet, separated from any food preparation or storage area, or utensil washing area, shall be provided for the storage of cleaning equipment and supplies, such as mops, buckets, brooms, and cleaners.

Proper storage of chemicals must be followed. Incompatible chemicals such as acids and bases must not be stored next to each other or on the same secondary containment pallet.



Floor drains inside chemical storage rooms are prohibited unless secondary containment facilities are provided for the stored chemicals. Hazardous materials or waste cannot be discharged into the sanitary sewer without approval from the local sanitation district and the local CUPA agency.

Rooms with substantial storage of hazardous materials or waste must be posted with the appropriate NFPA (National Fire Protection Association) placard. See *Attachment IV* for additional information.



XIII. JANITORIAL FIXTURES:

All food facilities shall be equipped with at least one of the following, to be used for general cleaning purposes and for the disposal of mop bucket waste and other liquid wastes:

- A. A one-compartment, non-porous janitorial sink/mop sink (stainless steel, porcelain or fiberglass).
- B. A slab, basin, or floor constructed of concrete or equivalent material, curbed and sloped to a drain and connected to approved sewerage, and provided with hot and cold running water (through a mixing valve).

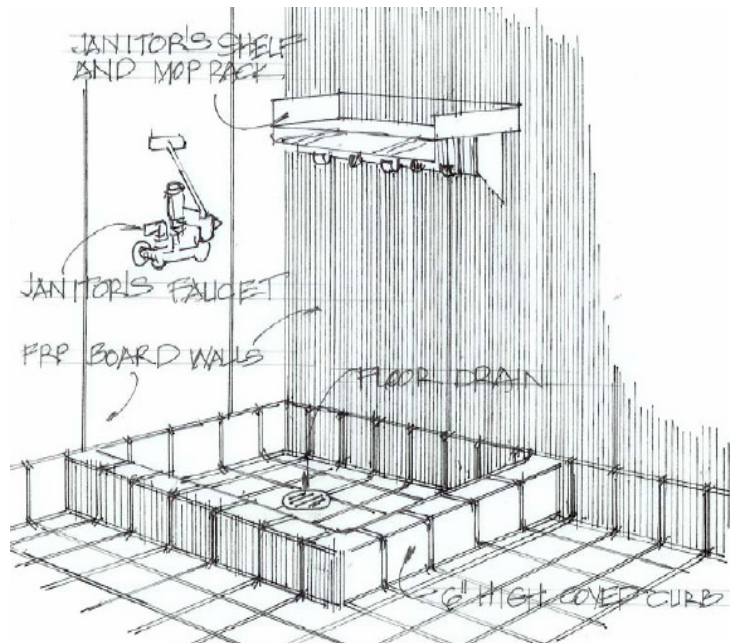

XIV. EQUIPMENT

A. APPROVED TYPE

All equipment and fixtures shall comply with National Sanitation Foundation (NSF) or equivalent standards, for material, construction, fabrication, and design. All equipment and equipment installation shall be subject to field evaluation. Specifications for equipment shall be available upon demand.



B. SINKS

Where utensils are routinely washed by hand, there shall be provided at least a three (3)-compartment metal sink (NSF approved or equivalent) with dual integral metal drain boards sloped towards the sink compartments. The sink compartments and drain boards shall be large enough to accommodate the largest utensil to be washed. The sink must be provided with adequate hot and cold running water. The minimum hot water supply for this sink will be 120°F. Utensil wash sinks may be either directly or indirectly connected to waste lines.

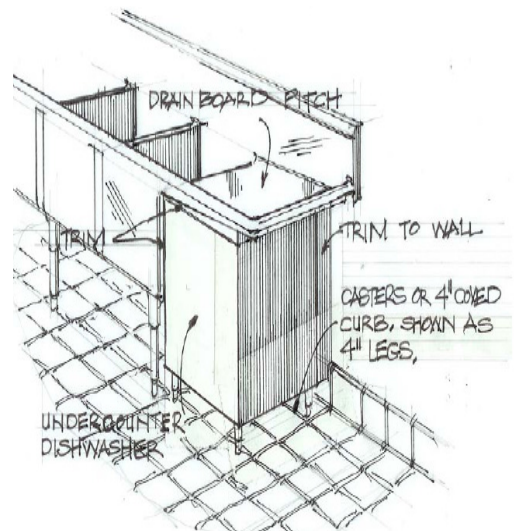

Where food is washed or rinsed, a food preparation sink will be required. Produce, meat and/or food preparation or wash sinks shall be dedicated sinks.

Preparation/wash sinks may not be used for hand washing or utensil/pot washing. Preparation/wash sinks shall be indirectly connected to waste lines.

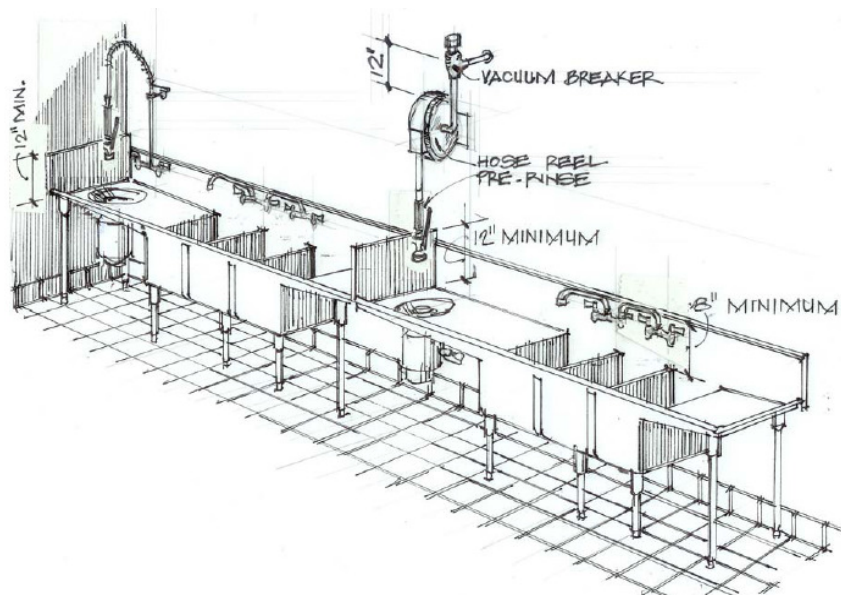

C. REFRIGERATION

Each food establishment where perishable food is prepared or stored must have adequate NSF approved or equivalent refrigeration. Condensate from walk-in refrigeration units must drain to properly located and approved floor sinks. Upright or reach-in refrigeration units may drain into an adequate self-contained evaporative unit. *Domestic type refrigeration units are not allowed.*

All walk-in refrigeration or freezer units must have approved floors, walls and ceilings, and have approved base coving at wall and floor junctures. Adequate shelving must be available in the units to prevent food products from being stored on the floor. Floor drains or floor sinks are not permitted inside the walk-in units unless they are indirectly connected to the sewer system through a legal air gap.



Large cold storage facilities often use freon or ammonia as the refrigerant materials. Ammonia is considered an acutely hazardous material and is subject to local hazardous materials permitting requirements and oversight. Large amounts of freon stored in large pressure vessels may also require permit and oversight by the local CUPA. Large refrigeration systems also require other maintenance related chemicals such as refrigeration oil and anti-corrosion chemicals. Additionally, large cold storage facilities install emergency generators which require diesel fuel.



Ammonia refrigeration vessel with refrigeration oil storage

D. ICE MACHINES

All icemakers shall be located within the approved food establishment. Condensate and ice melt shall be drained to an approved floor sink by means of an indirect connection.

E. STORAGE EQUIPMENT

Adequate storage shall be provided for all food establishments. Shelving shall be designed and constructed so as to be smooth, easily cleanable metal or wood, which has been finished and sealed. Shelves installed on a wall shall be sealed to the wall with silicone sealant or equivalent. The lowest shelf shall be at least six inches (6") above the floor, with a clear unobstructed area below. All shelves are to be set back at least two inches (2") from the drip line of the surface above. If shelves are supported by legs on the floor, the legs shall be round metal equipment legs. Establishments, which store food on pallets, must have pallet-moving equipment immediately available.

The Uniform Fire Code regulates the height of the storage racks and additional sprinkler heads within the racking system. We highly recommend that designers check with the local fire code inspector prior to the installation of any racking system.

XV. INSTALLATION REQUIREMENTS:

A. EQUIPMENT

All equipment shall be either easily moveable (e.g. on casters), light enough so as to be easily moved by one person (e.g. a light table), installed on raised six inch (6") rounded metal legs, or sealed to a minimum two inch (2") solid masonry island with minimum three eighths inch (3/8") radius coved base. If on an island, equipment shall overhang the base at least two inches (2"), but not more than the height of the island. Sealing to the floor is acceptable only on bulky equipment such as refrigerators and large bakery ovens. Gaps and spaces between pieces of equipment or equipment and walls, shall be sealed with silicone sealant (caulking is not an approved sealant). All equipment on counters, tables, and shelves that cannot be easily lifted shall be installed on approved four-inch (4") legs, or sealed to the table, shelves, etc.

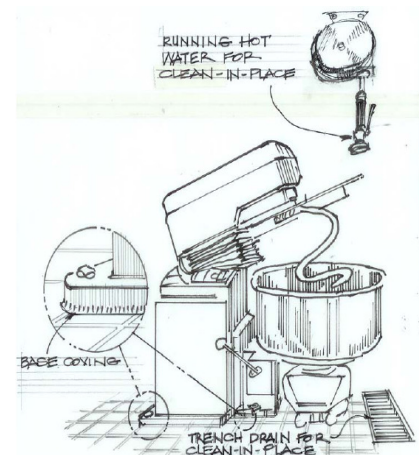
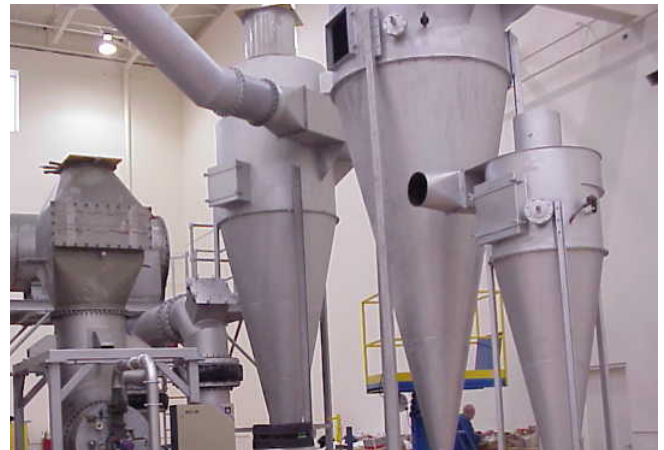

B. FLOOR DRAINS

Adequate floor drains should be provided in food preparation rooms, utensil or produce washing rooms, toilet rooms, garbage rooms, and in rooms subject to wash down type cleaning or wet conditions. Floor drains located directly outside walk-in refrigerators are acceptable if the floors in the walk-in units are sloped toward the drains.

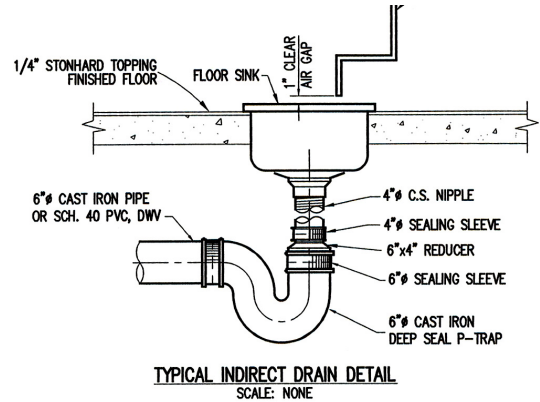

Floor drains are not permitted inside walk-in units unless they are indirectly connected to the sewer system through a legal air gap. The air gaps must be located outside the walk in refrigeration units

C. FLOOR SINKS



All steam tables, refrigerators (including walk-in boxes), steam kettles, ice machines, and similar items shall drain into floor sinks. Floor sinks shall be properly plumbed and installed with the sink

top flush with the floor surface. All condensate and similar liquid waste shall be drained by means of indirectly connected waste lines into open floor sinks. Horizontal runs of drain lines shall be at least six inches (6") off the floor, sloped toward floor sinks at a rate of one quarter inch (1/4") per foot, and shall terminate at least one inch (1") above the overflow rim of the floor sink. Floor sinks shall be located so that they are readily accessible for inspection, cleaning, and repairs, and not located in a walkway. Waste lines shall not cross any aisle, traffic area, or door opening. Floor sinks are not permitted inside walk-in units unless they are indirectly connected to the sewer system through a legal air gap.

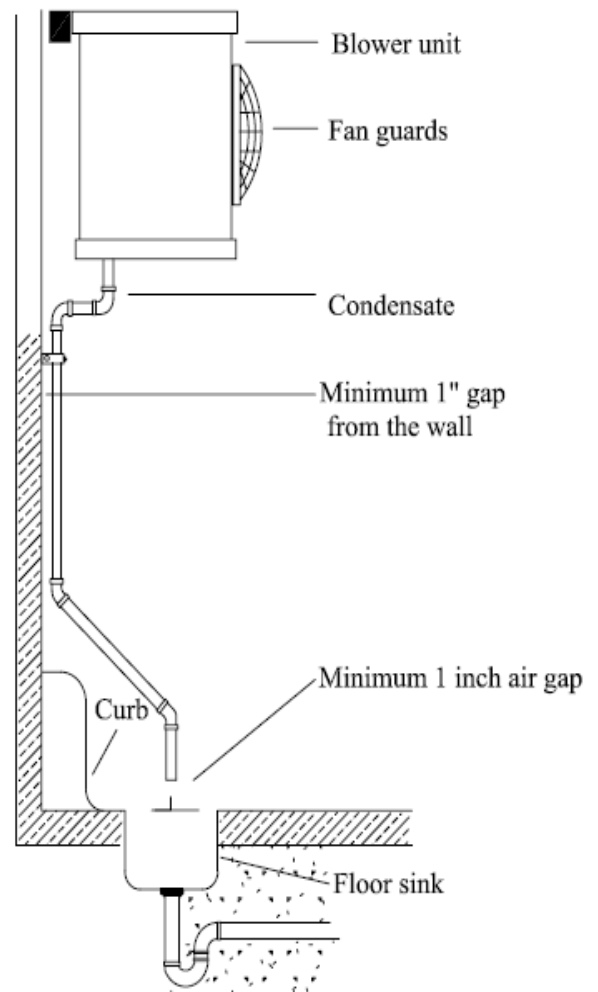

D. CONDUITS

All plumbing, electric, and gas conduit lines shall be concealed within the wall whenever possible. When it is not possible, all conduit runs should be at least one half inch (1/2") away from the walls or ceiling and at least six inches (6") off the floor. Conduit or pipelines shall not be installed across any aisle, traffic area, or door opening. Multiple runs or clusters of conduit or pipelines shall be furred in, encased in an approved runway, or other approved sealed enclosure.

XVI. SPECIAL REQUIREMENTS

A. CROSS CONNECTION / BACKFLOW DEVICES

The installation of any backflow prevention device requires an installation permit from the appropriate local building department. Testable backflow prevention devices typically require annual testing. This management of backflow prevention devices is usually overseen by the local environmental health department or the water purveyor.

Contact your local environmental health department for more information.

B. HAZARDOUS MATERIALS AND HAZARDOUS WASTE

Large food facility operations typically often acquire and store large volumes of hazardous chemicals such as lubricating oils, sanitizers, and compressed gases. In addition, these facilities may generate hazardous wastes such as waste lubricating oil, during normal operations. State and local codes require the disclosure of these items through a hazardous materials permit process. These permits are overseen by the local Certified Unified Program Agency (CUPA) agency such as the local health or fire department.

C. STORMWATER PROTECTION

Generally, a Regional Water Quality Control Board (RWQCB) requires ALL regulated facilities to submit an appropriate document to certify their storm water permit status. For instance, facilities that have outside activities or storage such as excess equipment and materials are required to submit a "Notice of Intent" to the local RWQCB. This procedure indicates to the RWQCB that you have outdoor exposures to storm water quality and will meet all the RWQCB permit Waste Discharge Requirements. If the facilities do not have anything stored your exterior areas, they are required to submit a "Notice of Non-Applicability" to the local RWQCB. This indicates to the local RWQCB that the facility does not have outdoor exposures that can impact storm water quality and that the facility does not require a permit.

Contact you local storm water program for further additional or specific information.

D. ONSITE SEWAGE DISPOSAL SYSTEMS – SEPTIC SYSTEMS

When public sewers are not available, onsite sewage disposal systems or septic systems are installed. The design of these systems is usually reviewed by the local environmental health office. Check with your local environmental health office for additional details.

Commercial food facilities that utilize onsite sewage disposal systems may also require a Waste Discharge Permit with the respective local RWQCB. Contact your local RWQCB for additional information.

E. ONSITE WATER WELL SYSTEMS

Facilities that receive domestic water from their own water well and piping system may be required to comply with the provisions of the Safe Drinking Water Act. A facility that acquires domestic potable water from its own well (s) AND serves 25 or more people in a 60 day period within the year, is considered a “non-transient non-community water system” and will be subject to the monitoring and reporting requirements indicated in the Safe Drinking Water Act.

Small water systems are typically under the oversight of the local environmental health agency or California Department of Health Services Drinking Water Branch. Larger community water systems are usually overseen by California Department of Health Services Drinking Water Branch.

F. CONSTRUCTION INSPECTIONS

All construction and equipment installations are subject to on-site inspections. During the course of construction, and particularly well before operating, operators or contractors are advised to call to have questions answered, or to request interim inspections.

It is highly recommended that construction inspections at 80% to completion be conducted to assure the progress of the work is in accordance to the approved plans.

G. FINAL INSPECTIONS

Final inspection and approval is required prior to beginning operation. Building departments and environmental health staff require AT LEAST THREE (3) WORKING DAYS PRIOR NOTICE TO ARRANGE FOR A FINAL INSPECTION. IT IS A MISDEMEANOR VIOLATION OF MOST LOCAL ORDINANCES TO BEGIN OPERATING WITHOUT A VALID PUBLIC HEALTH LICENSE.

- H.** *THE GUIDELINES CONTAINED IN THIS DOCUMENT ARE INTENDED TO PROVIDE A BASIS FOR THE CONSTRUCTION OF FOOD ESTABLISHMENTS THAT WILL FACILITATE OPERATION AND MAINTENANCE IN COMPLIANCE WITH LOCAL, STATE AND FEDERAL FOOD SAFETY LAWS AND REGULATIONS. ANY CONCEPTS THAT DEVIATE FROM THESE GUIDELINES MUST BE SUBMITTED FOR EVALUATION AND DECISION BY THIS DEPARTMENT FOR ACCEPTANCE OR DENIAL.*

FOOD FACILITY CONSTRUCTION REQUIREMENTS

THE FOLLOWING ARE BASIC CONSTRUCTION REQUIREMENTS. PLEASE CONTACT THE LOCAL OFFICE FOR OTHER SPECIFIC REQUIREMENTS.

	FOOD WAREHOUSE ² Dry, Non - refrigerated and Packaged	FOOD WAREHOUSE ² Refrigerated Packaged Perishable Food Areas (Seafood)	FOOD PROCESSING ^{1,2} Separate Room required
Floors / Coving	Smooth cleanable floors, Coving not required	Approved floor and coving required	Approved floor and coving required
Walls	NA	Approved walls must be smooth durable and cleanable	Approved wall materials / finish required
Ceilings	NA	Approved ceiling	Approved Ceiling –Smooth and cleanable
Utensil Washing Sink (three compartment sink)	NA	NA	Required when utensils are used and washed by hand
Food Preparation Sink	Not- required	Not-required	Required when food is washed or rinsed
Utility / Mop sink	Required	Required	Required
Hand wash Sink	NA	Required (Seafood)	Required in each process room
Janitorial Room	Recommended	Recommended	Required
Lighting	NA	Required	Required
Locker Rooms	Required with 5 or more employees	Required with 5 or more employees	Required with 5 or more employees
Fly Exclusion over doors	NA	Required (Seafood)	Required
Door self closing devices	NA	Required	Required

1. Food Processing includes packaging, packing and repacking, making, cooking, baking, mixing processing, bottling, canning, slaughtering, salvaging, preparing and handling open food products. Whole produce items can be considered packaged unless they are trimmed for any reason. Repacking produce items will require an approved hand wash sink near repacking areas.
2. Restrooms are required in all food facilities. All food facilities require approved floors, walls, ceilings, base covings, hand wash sinks and ventilation. Doors must be equipped with self-closing devices.

ATTACHMENT I

Mechanical Exhaust Ventilation Systems

MECHANICAL EXHAUST VENTILATION SYSTEMS Design, Calculations, and Operational Guidelines

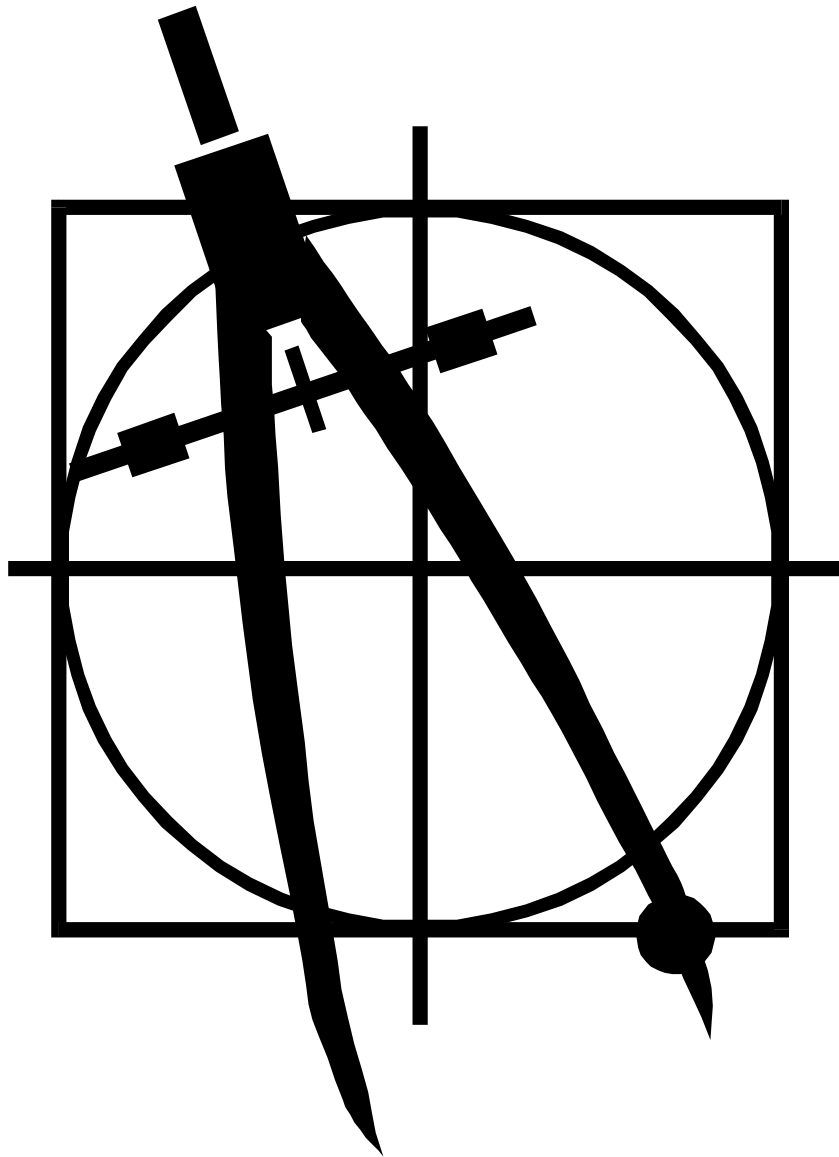

California Conference of Directors of Environmental Health

September, 2003

ACKNOWLEDGEMENTS

Appreciation is hereby expressed to the following people who offered insight, assistance, time, effort, and information in the development of the “Mechanical Exhaust Ventilation Systems – Design, Calculations, and Operational Guidelines”:

Jim Miller
Orange County Environmental Health Department

The members of the Southern California Food Technical Advisory Committee

The members of the Bay Area, Northern, and Central Valley Food Technical Advisory Committees

Dick Banneck
Dick Banneck Designs

John Taecker
Underwriters Laboratories (U.L.)

Bob Gunther
City of Long Beach

Bruce Hicks
Same Day Distributing

Dave Davis
Pro Reps West

Carl Marbery
International Conference of Building Officials (ICBO)

Don Dockray
Southern California Gas Company

Matt Russo
Equipment Marketing Associates

George Burgess
City of Vernon

TABLE OF CONTENTS

I.	Background.....	1
II.	Purpose and Scope	1
III.	Legal Authority and Applicable Codes and Standards	1
IV.	Definitions	2-3
V.	General Requirements.....	3-4
VI.	Exemptions From Providing Mechanical Exhaust Ventilation	4
VII.	Exhaust Hood Capacity Sizing.....	4-7
	A. <i>General requirements</i>	4-5
	B. <i>Minimum airflow calculations for canopy hoods</i>	5-6
	C. <i>Minimum airflow calculations for noncanopy hoods</i>	7
VIII.	Recommended Formulas For Specific Equipment.....	7-10
IX.	Grease Filters	10-12
X.	Exhaust Hood Ducting	12-14
XI.	Exhaust Hood Installation Requirements	14-15
XII.	Eye-Brow Hoods.....	15
XIII.	Water-Wash-Type Exhaust Hoods.....	16
XIV.	Recirculating Hood Systems (Ductless Hoods or Ventless Hoods)	16
XV.	Make-up Air.....	17
XVI.	Fire Extinguishing Systems.....	17-18
XVII.	Ventilation Requirements For Special Cooking Equipment and Operations	18
	A. <i>Table-top cooking operations</i>	18
	B. <i>Table-side serving display operations</i>	18
	Appendix 1. Applicable Codes and Standards.....	19
	Appendix 2. Figures 1 through 7.....	20-27
	Attachment. Mechanical Exhaust Ventilation Systems-Operational Guidelines	

MECHANICAL EXHAUST VENTILATION SYSTEMS

Design, Calculations, and Operational Guidelines

California Conference of Directors of Environmental Health

I. Background

Proper venting and capture of the gases, heat, grease, vapors, and smoke generated by cooking equipment is important; not only for fire prevention and sanitation purposes, but also for maintaining the health and well being of food service workers. In order to help prevent dangerous or unhealthful conditions within a food facility, it is critical that exhaust ventilation systems be designed, constructed, and operated in compliance with all applicable requirements.

II. Purpose and Scope

- These guidelines are intended to assist in determining mechanical exhaust ventilation requirements for equipment that generates grease, vapors, fumes, smoke, steam, heat, and/or odors.
- Exhaust ventilation systems are also reviewed and inspected by local building and fire authorities to determine compliance with applicable building and fire codes.
- The requirements contained within this document represent minimum standards, which may be superseded by local ordinances. Where there is a contradiction in the requirements, the stricter should apply.
- Due to the differing roles of the local enforcement agencies and local building departments not all health jurisdictions will be applying all portions of these guidelines.

III. Legal Authority and Applicable Codes and Standards

- A. California Uniform Retail Food Facilities Law, Section 114140.
- B. California Code of Regulations, Title 17, Article 10.4, Commencing with Section 13670.
- C. California Code of Regulations, Title 24, Part 4, Chapter 4-20, commencing with Section 4-2000.
- D. Applicable Codes and Standards (refer to Appendix 1).

IV. **Definitions**

- A. *Canopy Hood* – a hood designed so the inside edge overhangs or extends a horizontal distance not less than six inches beyond the outer edges of the cooking surface.
- B. *Compensating Hood* – a hood designed to introduce outside make-up air through an integrated section of the hood with little or no thermal conditioning. This design will typically provide 60-80% of the required make-up air through four basic discharge methods: short-circuit, face-discharge, back-discharge, and down-discharge. These methods may also be combined, such as a face and down-discharge arrangement. Short-circuiting hoods must be tested and listed by a qualified testing agency and installed/operated according to the listing conditions.
- C. *Convection Oven* – a gas or electric heated oven that uses a fan or blower to recirculate the heat throughout the interior of the oven.
- D. *Ducting* – the conduit that is used to convey exhausted air from the exhaust hood to the outside of the food facility.
- E. *Grease Extractor* – a series of baffles installed in the exhaust hood in such a way as to remove grease from the exhausted air using centrifugal force.
- F. *Grease Filter* – a device that is installed in the exhaust hood in such a way as to remove grease from the exhausted air by entrapment, impingement, adhesion, or other similar means.
- G. *Hood* – an air-intake device connected to a mechanical exhaust ventilation system for collecting and removing cooking effluent which contains grease, vapors, fumes, smoke, steam, heat, or odors which are generated by cooking equipment and warewashing machines.
- H. *Listed Equipment* – equipment and materials which, following evaluation and acceptance by a qualified testing agency, are placed on a list of certification. The listing shows that the equipment and materials comply with accepted national standards, which have been approved or evaluated for conformity with approved, or national standards.
- I. *Noncanopy Hood* – a hood that does not extend completely over the cooking equipment. A noncanopy hood is designed to be as close as possible to the cooking surface, usually 18 to 24 inches above it.
- J. *Plenum* – an air compartment or chamber to which one or more ducts are connected and which forms part of the supply-air, return-air, or exhaust air system.
- K. *Portable* – equipment having the properties of being portable, weighing less than 80 pounds, not exceeding three feet in any plane, and having utility connections

designed to be disconnected or of sufficient length to permit equipment movement for cleaning.

- L. *Recirculating Hood System (Ductless hoods or Ventless hoods)* – a self-contained air exhaust system that removes grease, vapors, fumes, smoke, steam, and odors from the exhausted air; and then reintroduces the filtered air back into the food facility. The grease, vapors, fumes, smoke, and steam are normally removed using a variety of systems such as water sprays, electrostatic precipitators, or multiple filter banks. The odors are typically removed using activated charcoal filters. Recirculating hood systems are not designed to eliminate heat from the exhausted air. Recirculating hood systems are also known as ductless or ventless hoods.
- M. *Type I Exhaust Hood* – a hood that is designed to collect and remove all types of cooking effluent from the exhausted air.
- N. *Type II Exhaust Hood* – a hood that is designed to collect and remove **only** steam, vapors, heat, or odors.
- O. *Water-Wash-Type Exhaust Hood* – a Type I hood which uses water to remove accumulated grease from the grease extractors.

V. **General Requirements**

- A. Section 114140 of CURFFL states in part, “Ventilation shall be provided to remove toxic gases, heat, grease, vapors, and smoke from the food establishment. All areas shall have sufficient ventilation to facilitate proper food storage and to provide a reasonable condition of comfort for each employee, consistent with the job performed by the employee. On or after January 1, 1985, there shall be provided mechanical exhaust ventilation at or above all newly installed cooking equipment as required in Article 10.4 (commencing with Section 13670) of Title 17 of, and Chapter 4-20 (commencing with Section 4-2000) of Part 4 of Title 24, of the California Code of Regulations. “
- B. The Uniform Mechanical Code states, “Hoods shall be installed at or above all commercial-type deep fat fryers, broilers, fry grills, steam-jacketed kettles, hot-top ranges, ovens, barbecues, rotisseries, dishwashing machines and similar equipment which produce comparable amounts of steam, smoke, grease or heat in a food-processing establishment. For the purpose of this section, a food-processing establishment shall include any building or portion thereof used for the processing of food but shall not include a dwelling unit.”
- C. Listed ventilation equipment shall be installed and used according to the manufacturer’s installation and operating instructions. A copy of the instructions

shall be readily available for review by the enforcement officer. Nonlisted ventilation equipment, when approved by the authority having jurisdiction, shall be constructed, installed and used in accordance with all applicable requirements contained in the codes identified in Appendix I of these guidelines.

- D. Exhaust ventilation systems shall conform to all local building and fire codes and have all necessary approvals from the local building and fire authorities.

VI. **Exemptions From Providing Mechanical Exhaust Ventilation**

- A. Section 114140 of CURFFL also states, "This section shall not apply to cooking equipment when such equipment has been submitted to the department for evaluation, and it has found that the equipment does not produce toxic gases, smoke, grease, vapors, or heat when operated under conditions recommended by the manufacturer. The department may recognize a testing organization to perform any necessary evaluations." In this case, the department means California Department of Health Services.

Note: Local building and fire authorities may still require mechanical exhaust ventilation over equipment exempted by the department.

- B. Refer to items marked with an asterisk in Section VIII of this document for examples of recommended equipment exemptions.

VII. **Exhaust Hood Capacity Sizing**

A. *General requirements*

1. Hoods that have been evaluated and listed shall be sized and installed in accordance with the terms of their listing and according to the manufacturer's instructions.
2. Type I hoods for use over charcoal and other solid-fuel charbroilers shall be provided with separate exhaust systems (e.g., separate exhaust duct and exhaust fan).
3. When different types of cooking equipment are installed under a common hood, the entire hood shall be designed using the formula that produces the highest flow rate. For example, a single hood installed over a gas charbroiler, fryer, and range, shall be designed using the formula for the charbroiler (Formula 1).

4. When cooking equipment is installed back to back and is covered by a common island-type hood, the minimum airflow required may be calculated using the formula for three sides exposed.
5. In sizing exhaust hood airflow, the formulas are intended to meet the needs of most installations. Due to variables at each installation site, such as cross currents, alterations may be required in order to provide an exhaust system which properly removes the cooking effluent from the kitchen.

B. *Minimum airflow calculations for canopy hoods*

The Uniform Mechanical Code separates cooking equipment into the following four categories for the purpose of calculating minimum required withdrawal airflow:

1. *Key to formulas*

A = The horizontal surface area of the hood, in square feet.

D = The distance, in feet, between the lower lip of the hood and the cooking surface.

P = That part of the perimeter of the hood that is open, in feet.

Q = Quantity of air in cubic feet per minute (CFM).

2. **Formula 1**

For Type I hoods located above solid-fuel cooking equipment and grease-burning charbroilers.

<u>Number of Exposed Sides</u>	<u>Formula</u>
4 (island or central hood)	$Q=300A$
3 or less	$Q=200A$
Alternate formula	$Q=100PD$

3. **Formula 2**

For Type I hoods located above high-temperature cooking equipment, such as deep-fat fryers and woks.

<u>Number of Exposed Sides</u>	<u>Formula</u>
4 (island or central hood)	$Q=150A$
3 or less	$Q=100A$
Alternate formula	$Q=100PD$

4. **Formula 3**

For Type I hoods located above medium-temperature cooking equipment, such as rotisseries, grills, ranges.

<u>Number of Exposed Sides</u>	<u>Formula</u>
4 (island or central hood)	$Q=100A$
3 or less	$Q=75A$
Alternate formula	$Q=50PD$

5. **Formula 4**

For Type I hoods located above low-temperature cooking equipment, such as medium-to-low-temperature ranges, roasters, roasting ovens, and pastry ovens. This formula is also used for Type II hoods located above nongrease generating equipment, such as high-temperature dish machines.

<u>Number of Exposed Sides</u>	<u>Formula</u>
4 (island or central hood)	$Q=75A$
3 or less	$Q=50A$
Alternate formula	$Q=50PD$

6. **Examples**

The following two examples will demonstrate the use of the hood sizing formulas for canopy hoods.

For these examples, we will use the dimensions provided in Figures 1 and 2.

a. *In the first example, we will assume that all of the cooking equipment under the hood is of the medium-temperature category. Therefore, we will use formula 3.*

Since there are three exposed sides, the first formula we will use is $Q=75A$.

The area (A) is obtained by multiplying the length times the width;
 $12 \text{ ft.} \times 4 \text{ ft.} = 48 \text{ sq. ft.}$

This A value is then inserted into the $Q=75A$ formula; $Q=75 \times 48$;
 $Q=3,600 \text{ CFM.}$

Therefore, a minimum of 3,600-CFM airflow would be required for this particular hood.

b. *In the second example, we will use the same dimensions and cooking equipment as in the first example. However, this time we will use the alternate formula, $Q=50PD$.*

The P in this example is obtained by adding together the length and width dimensions for the exposed sides, $4 \text{ ft.} + 12 \text{ ft.} + 4 \text{ ft.} = 20 \text{ ft.}$

The D in this example is 4 ft.

By inserting these figures into the formula we obtain the required CFM;

$Q=50 \times 20 \times 4$; $Q=4,000 \text{ CFM.}$

Therefore, using the alternate formula, a minimum airflow of 4,000 CFM would be required for this hood.

C. *Minimum airflow calculations for noncanopy hoods*

The volume of air exhausting through a noncanopy hood to the duct system shall not be less than 300 CFM per linear foot of cooking equipment. The formula to use when determining the minimum airflow for a noncanopy hood is $Q=300 L$.

1. *Key to the formula*

Q=Quantity of air in CFM

L=Linear footage of the cooking equipment.

2. *Example*

The following example will demonstrate the use of the hood sizing formula for noncanopy hoods.

For this example we will use the dimensions provided in Figure 3.

The lineal footage of cooking equipment is given as 12 feet. By inserting the 12 feet into the formula for noncanopy hoods, $Q=300 L$, we get $Q=300 \times 12$; $Q=3,600$ CFM.

Therefore, this hood requires a minimum airflow of 3,600 CFM

Note: In designing kitchen exhaust systems, designers must determine the resistance to airflow (static pressure) that is inherent in every system. By doing so, properly sized fans and motors may be selected. This will result in a quieter, smoother operating, and more efficient system.

VIII. **Recommended Formulas for Specific Equipment**

<u>Equipment</u>	<u>Hood Type</u>	<u>Formula To Use</u>
Bain Marie	II	4
Barbecue (solid fuel, e.g., wood or charcoal)	I+	1
Broiler (Gyro)	I	3
Charbroiler		
• Underfired (solid fuel or gas-fired, including radiant units)	I+	1
• Overfired or salamander	I	2
• Underfired (electric)	I	3
Cheese Melter (top browning and melting only)	II	4
Chinese Range (wok)	I	2
Coffee Equipment		
• Urn or brewer	*	—
• Roaster (gas)	II	4
• Roaster (electric)	*	—

Corn on the Cob Warmer	*	—
Crepe Maker		
• Portable	*	—
• Nonportable	II	4
Deep Fat Fryer	I	2
Dishwashing Machine		
• High temperature	II	4
• Chemical sanitizing or any undercounter unit	*	—
Griddle, Grooved Griddle or Grill	I	3
Hot Dog Warmer	*	—
Hot Plate		
• Electric (one burner only)	*	—
• Gas (Maximum of 5,000 BTU's)	*	—
• Multiple hot plates or larger than exempted units	I	3
Kettle (steam jacketed)	II	4
Kettle (candy)	II	4
Masa Cookers	II	4
Mongolian Barbeque	I	1
Ovens		
• Maximum temp. of 250°F (thermostatically controlled)	*	—
• Electric convection oven, 12 KW or less, without grease vapor generation (for baking bread products).	*	--
• Gas or electric (except 12 KW or less conv. ovens), greater than 250°F, <u>without grease vapor generation</u> (such as enclosed ovens for baking pizza and bread products only)	II	4
• Gas or electric, greater than 250°F, <u>with grease vapor generation</u> (such as conveyor pizza ovens, roasting ovens, and rotisseries)	I	3
• Portable ovens (microwave, cook and hold)	*	—
• Solid fuel-fired pizza and baking ovens	I+	4
• Tandoor Oven (solid fuel or gas-fired)	I+	1
• Combi Oven	I	3
Popcorn Popper		
• Without external grease vapor release	*	—
• With external grease vapor release	I	3
Pressure Fryer	I	2
Range		

• High temp, e.g., “hot tops”	I	2
• All others	I	3
Rethermalizer		
• Without external grease vapor release	II	4
• With external grease vapor release	I	3
Rice Cookers		
• Electric	*	—
• Gas	II	4
Rotisserie		
• Open or high temp	I	3
• Enclosed with max. ambient cavity temperature of 250°F	*	—
Skillet (tilting or braising)	I	2
Steam Cooker	II	4
Steam Table (hot holding only)	*	—
Toaster (bread only)		
• Portable	*	—
• Nonportable	II	4
Waffle Cone Maker / Waffle Iron		
• Portable	*	—
• Nonportable	II	4

+ Cooking equipment that uses solid fuel must be provided with a separate exhaust system.

* Equipment marked with an asterisk typically does not need mechanical exhaust ventilation. However, the following criteria should be taken into consideration when determining the need for mechanical exhaust ventilation:

- Installation of other unventilated heat generating equipment in the same area, e.g., refrigeration condensers, steam tables, or counter-top equipment;
- Presence of heating/cooling (HVAC) system;
- Size of the room or area where the proposed equipment will be installed, including ceiling height;
- How the proposed equipment will be operated, e.g., the types of food prepared, how often, etc.;
- Relative size of the proposed equipment, e.g., physical size and weight, BTU's/KW's;
- Nature of the emissions, e.g., grease, heat, steam, etc.;

- Temperature at which the proposed equipment operates. Cooking equipment that has a factory-set thermostat that cannot exceed 250°F normally does not need mechanical exhaust ventilation;
- Method of producing heat, e.g., gas, electricity, solid fuel, etc.
- Adequate amount of general ventilation: In poorly ventilated confined areas where the proposed equipment (like ovens and low-temp. dishwashers) is located, adequate general ventilation could be provided by a ceiling or wall exhaust fan that provides an air change rate of 3-5 minutes per change.

IX. Grease Filters

- A. Grease filters are designed to remove grease particles from the exhaust air stream. Exhaust systems that have broken, missing, or undersized filters are prone to collect accumulations of highly combustible grease deposits throughout the entire duct system. Because of the chimney effect created in vertical ductwork, a very intense rapidly spreading flash fire can engulf the entire system.
- B. Type I hoods shall be equipped with approved grease filters or grease extractors designed to remove grease from the exhausted air.
- C. The most common grease filters currently in use are the baffle-type. Baffle-type filters simplify the cleaning process since most of the grease deposits run off the baffles to a collection device. The old style mesh-type filters are not acceptable in new installations. NFPA 96, ANSI NSF Standard 2, and UL 1046 no longer recognize the old style mesh type filters. They may present a fire hazard and decrease airflow as they become clogged with grease.
- D. Grease filters and extractors shall be of such size, type, and arrangement as will permit the required quantity of air to pass through such units at rates not exceeding those for which the filter or extractor was designed and approved. The optimum operating velocities, measured in feet per minute (FPM), vary from filter to filter. Therefore, the manufacturer's specifications should be consulted to obtain the appropriate rates for each specific filter.
- E. *Number of Filters Required*
1. It is important to select the proper number of grease filters for the hood. Too few filters increase the resistance to airflow and raise the filter cleaning frequency.
 2. The minimum required number of filters for a particular hood can be calculated by dividing the total volume of air to be exhausted, in CFM, by the optimum operating velocity of the filter, in FPM. This number is then divided

by the actual square footage of the filter (excluding the frame). The resulting figure represents the minimum number of filters required to efficiently remove the grease from the exhausted air.

Example:

Assume the following:

- An exhaust hood with a minimum required airflow of 3,250 CFM.
- Baffle type filters with a nominal size of 16" x 20", have an actual filtering surface of 14" x 18". (Nominal size minus the frame equals the actual filtering area.)
- An optimum operating velocity of 360 FPM for the filter.

$$\frac{\text{Volume of Air Exhausted}}{\text{Operating Velocity of Filter(FPM)}} = \text{Filter Area Needed (sq. ft.)}$$

$$\frac{3,250 \text{ CFM}}{360 \text{ FPM}} = 9 \text{ sq. ft.}$$

Next, convert the actual filter area to square feet:

$$14 \text{ in.} \times 18 \text{ in.} = 252 \text{ sq. in.}$$

$$\frac{252 \text{ sq. in.}}{144 \text{ sq. in./sq. ft.}} = 1.75 \text{ sq. ft.}$$

Then divide the 9-sq. ft. of needed filter area by sq. ft. per filter:

$$\frac{9 \text{ sq. ft.}}{1.75 \text{ sq. ft.}} = 5 \text{ filters}$$

Therefore, in this example, 5 filters would be required to provide adequate removal of the grease.

- F. Any space in the hood not occupied by a filter should be blanked off with sheet metal. Blanks may be placed above nongrease producing equipment such as a steam table, in order to achieve a better draw where it is needed the most. As much as possible, the blanks should be divided equally between the filters. This will ensure optimum performance and will equalize the air velocity over the entire length of the hood opening.
- G. It is important to install filters at the ends of the hood. However, grease filters should not be installed directly over a broiler flue, or any other flue from cooking equipment. Hot gases can make the filters very difficult to clean and may damage them.
- H. The minimum distance between the lowest edge of a grease filter and the actual cooking surfaces shall be as follows:

Type of Cooking

Minimum Separation Required

No exposed flame grills, french fryers, etc.	2 feet
Exposed flame and burners	2 feet
Exposed charcoal and charbroiler-type fires	3 1/2 feet

- I. Filters shall be installed at an angle not less than 45 degrees from the horizontal and shall be equipped with a drip tray beneath the lower edge of the filter. This enables the grease to be collected in the drip tray and avoids grease dripping into food, or on food preparation surfaces.
- J. All grease collecting equipment shall be accessible for cleaning. Filter units shall be installed in frames or holders with handles so as to be readily removable without the use of tools, except where the system is designed for in-place cleaning.
- K. Proper hood design will keep the temperature at the filters less than 200° Fahrenheit. When the temperature at the filters is less than 200° Fahrenheit, the grease deposits will be brownish in color and can be easily removed. When the temperature exceeds 200° Fahrenheit, the grease deposits tend to bake on the filters. The color of the deposits will darken and become extremely difficult to remove.
- L. Filter equipped exhaust systems shall not be operated with damaged or missing filters.

X. Exhaust Hood Ducting

- A. A separate duct system shall be provided for each Type I hood, except that a single duct system may serve more than one hood located in the same story of the building, provided that all hoods served by the system shall be located in the same room or adjoining rooms.
- B. Ducting shall be installed in compliance with local building and fire codes.
- C. Exhaust ducts from hoods shall be totally separated from all other ventilation systems.
- D. If the hood length exceeds 12 feet, it is necessary to provide two discharge ducts from the top of the hood to the main exhaust duct. For listed hoods, refer to the manufacturer's installation and operating conditions to determine if a distance of greater than 12 feet between ducts is permitted.
- E. Exhaust outlets for the exhaust hood ducting shall extend through the roof unless otherwise approved by the local building official. Such extension shall be at least 24 inches above the roof surface; at least ten feet from an adjacent building, adjacent

property line, or air intake into any building; and shall be located at least ten feet above the adjoining grade level. However, exhaust outlets for ducting may terminate at least five feet from an adjacent building, adjacent property line, or air intake into a building if the air from the exhaust outlet is discharged away from such locations. Exhaust air may be reintroduced into the food establishment only through a properly designed and approved air recovery system, such as a ductless hood system.

- F. Exposed duct systems serving a Type I hood shall have a clearance of at least 18 inches from unprotected combustible construction. This clearance may be reduced to not less than three inches, provided the combustible construction is protected with material required for one-hour fire-resistive construction. Hoods less than 12 inches from the ceiling or wall, including the space between the duct and the duct shaft, shall be flashed solidly. Flashing shall be of either the same materials used in the construction of the hood, or of other materials conforming to one-hour fire-resistive construction. Check with your local building and fire authorities to determine other acceptable means of meeting this requirement.
- G. Duct systems serving a Type I hood shall be designed and installed in a manner to provide an air velocity within the duct system of not less than 1,500 FPM and not to exceed 2,500 FPM. The optimum duct velocity is 2,000 FPM.
- H. *Duct Sizing*
1. The duct leading from the exhaust hood to the exhaust outlet shall be sized correctly. The velocity of the exhaust air shall be high enough to minimize condensation on the various parts of the duct system.
 2. The following formula shall be used to determine the correct duct size:
$$\frac{\text{Volume of air exhausted (CFM)}}{\text{Duct Velocity (FPM)}} = \text{Duct area needed (sq. ft.)}$$
- In an example of this calculation we will assume the following:*
- An exhaust hood with a minimum required airflow of 3,600 CFM.
 - A duct velocity of 2,000 FPM.
- By inserting this data into the formula we will obtain the required duct size:
- $$\frac{3,600 \text{ CFM}}{2,000 \text{ FPM}} = 1.8 \text{ sq. ft.}$$
- I. A circular duct requires a smaller space. If rectangular ducts are used, they should be as nearly square as possible.
- J. The duct take-off at the top of the hood should be transitioned. This will reduce the entrance loss and resistance offered to airflow at the ducting entrance point.

- K. The bends and elbows of the ductwork should be kept at a minimum. When elbows are used, a radius of 2 to 2 1/2 times the duct diameter is recommended. This will minimize the resistance against which the blower must move the air.
- L. Duct systems serving a Type I hood shall be constructed and installed so that grease will not collect in any portion of the ducting. The ducting shall slope not less than 1/4 inch per linear foot toward the hood or toward an approved grease reservoir. Where horizontal ducts exceed 75 feet in length, the slope shall be not less than one inch per linear foot.
- M. Any portion of the ducting that is inaccessible from the duct entry or discharge shall be provided with cleanout openings. Cleanout openings shall be equipped with tight fitting doors that are constructed of the same material and thickness as the ducting. The doors shall be equipped with latches that will hold the door tightly closed. Doors shall be designed so that they can be opened without the use of tools.
- N. Ducts and plenums shall be constructed of carbon steel not less than .055 inch (No. 16 gage), or stainless steel not less than .044 inch (No. 18 gage) in thickness.
- O. All seams and joints shall have a liquid-tight, continuous external weld.
- P. All ducting that is exposed to the outside atmosphere and subject to corrosion shall be protected against such corrosion. Galvanization of metal parts, protection with noncorrosive paints, or installation of waterproof insulation are acceptable methods of protection.

XI. Exhaust Hood Installation Requirements

- A. Canopy hoods must overhang, or extend a horizontal distance of at least 6 inches beyond the outer edge of the cooking surfaces on all open sides. This distance is to be measured from the inside lip of the hood.
Note: The minimum six-inch overhang may not be sufficient to capture all of the smoke, vapors, or grease generated by some cooking equipment. A 12-18 inch overhang is recommended for large or stacked ovens, conventional steamers, large tilting kettles, and bain maries. A 12-18 inch overhang at the side of the hood is also recommended for charbroilers when the equipment is located at the end of the cookline. (The minimum recommended overhang around the perimeter of an island hood installed over solid fuel cooking equipment is 12 inches.)
- B. The vertical distance between the lower lip of the hood and the cooking surface shall not exceed 4 feet.
- C. Every portion of a Type I hood shall have a clearance from combustible construction of not less than 18 inches. This clearance may be reduced to not less than three

inches, provided the combustible material is protected with materials as specified for one-hour fire-resistive construction on the hood side.

- D. Canopy hoods shall be flashed to the ceiling and adjacent walls. The flashing shall be constructed of the same material and thickness as the hood. **See Figures 4 and 5 for illustrations of the flashing methods.**
- E. Exhaust hoods shall be constructed of galvanized steel, stainless steel, or copper in compliance with the Uniform Mechanical Code.
- F. All joints and seams shall be liquid-tight and smooth for ease of cleaning. Approved construction methods and materials shall be used for sealing joints and seams.
- G. Pop rivets, metal screws, or other similar exposed fasteners shall not be used on the internal surfaces of a hood.
- H. Every hood shall be securely fastened in place by noncombustible supports. Exposed support hangers shall be of an easily cleanable design and construction. Threaded rods and chains are not acceptable.
- I. All conduit and fire protection piping shall be installed outside the hood, except for conduit or fire protection piping that leads from outside the hood directly to approved lighting fixtures or fire protection nozzles located inside the hood. All conduit or piping installed inside the hood shall be installed at least 3/4 inch away from the hood surface to facilitate cleaning.
- J. Light fixtures installed inside exhaust hoods shall be marked, "For use within commercial cooking hoods", or equivalent.

XII. Eye-Brow Hoods

- A. Eye-brow hoods are acceptable for use with either Type I or Type II hoods.
- B. The minimum required airflow shall be calculated using the formula for noncanopy-type hoods, i.e., $Q = 300L$.
- C. The eye-brow hood shall overhang, or extend a horizontal distance of at least six inches, beyond all areas of the equipment out of which steam, grease, odors, smoke, or heat will be emitted. **See Figures 6 and 7 for examples of this type of installation.**

Note: The minimum six inch overhang may not be sufficient to capture all of the smoke, vapors, or grease generated by some cooking equipment. A 12-18 inch overhang is recommended for large or stacked ovens, conventional steamers, large tilting kettles, and bain maries.
- D. When eye-brow hoods are equipped with grease filters or grease extractors, the filters or extractors shall be readily accessible for cleaning and servicing.

XIII. Water-Wash-Type Exhaust Hoods

- A. Water-wash-type hoods operate under the following principles: As the exhausted air moves at a high velocity past a baffle system, the heavier-than-air particles of grease are thrown out of the airstream by centrifugal force. The extracted grease is collected in grease gutters within the hood until removed by the daily cleaning cycle. The cleaning cycle is initiated when the exhaust hood is turned off. Hot detergent water is automatically sprayed onto the baffle system, thereby removing the grease deposits from the baffles. This wastewater is then drained off to the sewer or other approved waste removal system.
- B. In order to protect the potable water supply, an approved backflow prevention device, such as a reduced pressure principle device (RP device), is required to be installed on the water inlet pipe, prior to the detergent pump solenoid.
- C. The wastewater from a water-wash-type hood shall be drained through an air gap separation into an approved receptacle, such as a floor sink.

XIV. Recirculating Hood Systems (Ductless hoods or Ventless hoods)

- A. Where it is not possible to exhaust the air to the out-of-doors, a nonducted, self-contained exhaust system may be a viable option for the food establishment.
- B. Gas cooking equipment, when approved by the authority having jurisdiction, may only be installed below those hoods that are equipped to remove combustion by-products.
- C. The cooking equipment and exhaust system shall be interlocked such that when the hood is not functional or when the hood is operating at less than 85% efficiency, the cooking equipment will not operate.
- D. An approved backflow prevention device shall be installed when potable water is plumbed to the hood system, e.g., on the water inlet pipe, prior to the water pump solenoid. The wastewater from the scrubbing operation shall be drained through an air gap separation into an approved receptacle, such as a floor sink.
- E. Since a nonducted exhaust system does not normally remove the heat from the exhausted air, additional air conditioning may be required.

XV. Make-up Air

- A. Each room provided with an exhaust system shall have supplied to the room an amount of filtered and tempered make-up air equal to the amount of air to be exhausted. If make-up air were not provided, the building would be under a negative pressure which could cause the following problems:
 - 1. The exhaust fan would not be capable of exhausting the design volume of air because the air would not be available.
 - 2. Negative pressure would cause improper venting of water heaters, space heaters, or other individually vented gas appliances in the building.
 - 3. A negative pressure will cause a surge of unconditioned outside air into the building whenever the doors are opened, which may also allow the entrance of flies into the facility.
- B. In order to provide an efficient air exchange system, the following factors should be taken into consideration when evaluating a make-up air system:
 - 1. The number and location of return air registers should be such as to provide uniform distribution of make-up air throughout the facility, taking into consideration cross drafts, room configurations, and required air flows.
 - 2. The use of properly designed registers and diffusers will help to slow down the air velocity and evenly distribute the make-up air.
 - 3. The make-up air registers should be located so as to prevent a short-circuiting of the air being supplied for the exhaust system.
- C. Windows and doors shall not be used for the purpose of providing make-up air.
- D. The exhaust and make-up air systems shall be connected by an electrical interlocking hardwired connector so that one system cannot be operated when the other system is off.
- E. Compensating hoods shall extract at least 20 percent of their required exhaust airflow from the kitchen area around the hood. Compensating hoods, that have been evaluated and listed, shall be sized and installed in accordance with the terms of their listing, and according to the manufacturer's instructions.

XVI. Fire Extinguishing Systems

- A. Approved automatic fire extinguishing systems shall be provided for the protection of commercial-type cooking equipment. The requirement for protection does not include equipment that does not create or generate grease-laden vapors, such as steam kettles and steam tables.

- B. Deep fat fryers, ranges, griddles, broilers, and other cooking equipment which may act as a source of ignition for grease in the hood, grease removal device, or duct, shall be protected by approved fire extinguishing equipment installed in accordance with the fire code adopted by the jurisdiction. Necessary approvals must be obtained from the local fire authorities prior to putting equipment into operation.
- C. The operation of any fire extinguishing system shall automatically shut off all sources of fuel and heat to all equipment requiring protection by an extinguishing system. Any gas appliance not requiring protection, but located under ventilating equipment, shall also be shut-off. All shut-off devices shall be considered an integral part of the system, and shall function when the system is in operation. The automatic shut-off device must be manually resettable prior to fuel or power being restored.
- E. Exhaust hood fans shall continue to operate after the fire extinguishing system has been activated, unless fan shutdown is required by any component of the ventilation system, or by the design of the extinguishing system.

XVII. Ventilation Requirements for Special Cooking Equipment and Operations

- A. *Table-top cooking operations*
Cooking equipment, which is located at customer dining tables, must be provided with approved mechanical exhaust ventilation. Korean barbecues and Japanese Teppan-style cooking typify these table-top cooking operations.
- B. *Table-side serving display operations*
Traditional serving display operations, such as flambéing, may not be required to provide mechanical exhaust ventilation, unless excessive amounts of smoke, grease, steam, vapors, and/or heat are emitted. These serving display operations are not intended to cook the food, but merely "finish off" the product prior to serving. Local building and fire officials should be contacted for their requirements.

APPENDIX I

Installation Codes and Standards

Uniform Building Code	International Building Code
Uniform Fire Code	International Fire Code
Uniform Mechanical Code	International Mechanical Code
Uniform Plumbing Code	International Plumbing Code
International Fuel Gas Code	
National Electrical Code (NFPA 70)	
Standard for Ventilation Control and Fire Protection of Commercial Cooking Operations (NFPA 96)	

Product Standards Used by Listing Agencies for Cooking System Components

ANSI Z83.11, CGA 1.8 - Gas Food Service Equipment
ANSI/NSF 2 – Food Service Equipment
ANSI/NSF 4 – Commercial Cooking, Rethermalization and Hot Food Holding and Transport Equipment
ASTM E814 – Fire Tests of Through Penetration Fire Stops
IAPMO PS 98 – Backflow Protection for Grease Fire Suppression Systems
ICBO AC101 – Grease Ducts, Flexible Enclosure Systems
ICBO AC105 – Recirculating Commercial Kitchen Hoods
ICBO AC121 – Grease Duct Systems, Self-Enclosed
UL 197 – Commercial Electric Cooking Appliances
UL 296 – Oil Burners
UL 300 – Fire Testing of Fire Extinguishing Systems for Protection of Restaurant Cooking Areas
UL 705 – Power Ventilators
UL 710 – Exhaust Hoods for Commercial Cooking Equipment
UL 762 – Power Ventilators for Restaurant Exhaust Appliances
UL 795 – Commercial-Industrial Gas Heating Equipment
UL 1046 – Grease Filters for Exhaust Ducts
UL 1254 – Pre-Engineered Dry Chemical Extinguishing System Units
UL 1479 – Fire Tests of Through Penetration Fire Stops
UL 1570 – Fluorescent Light Fixtures
UL 1571 – Incandescent Light Fixtures
UL 1572 – High Intensity Discharge Fixtures
UL 1978 – Grease Ducts
UL 2162 – Wood-Fired Baking Ovens – Refractory Type
UL 2221 – Fire Endurance Performance of Grease Duct Enclosure Assemblies Grease Ducts

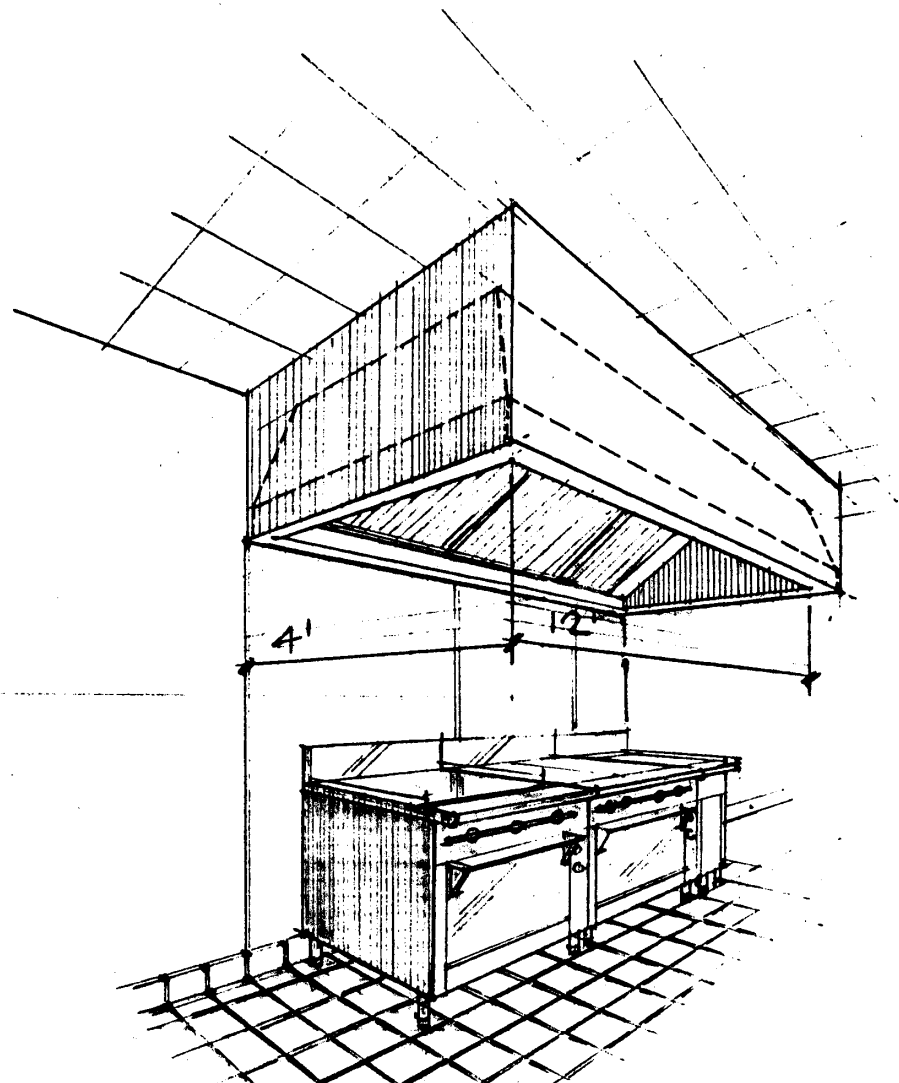

FIGURE 1

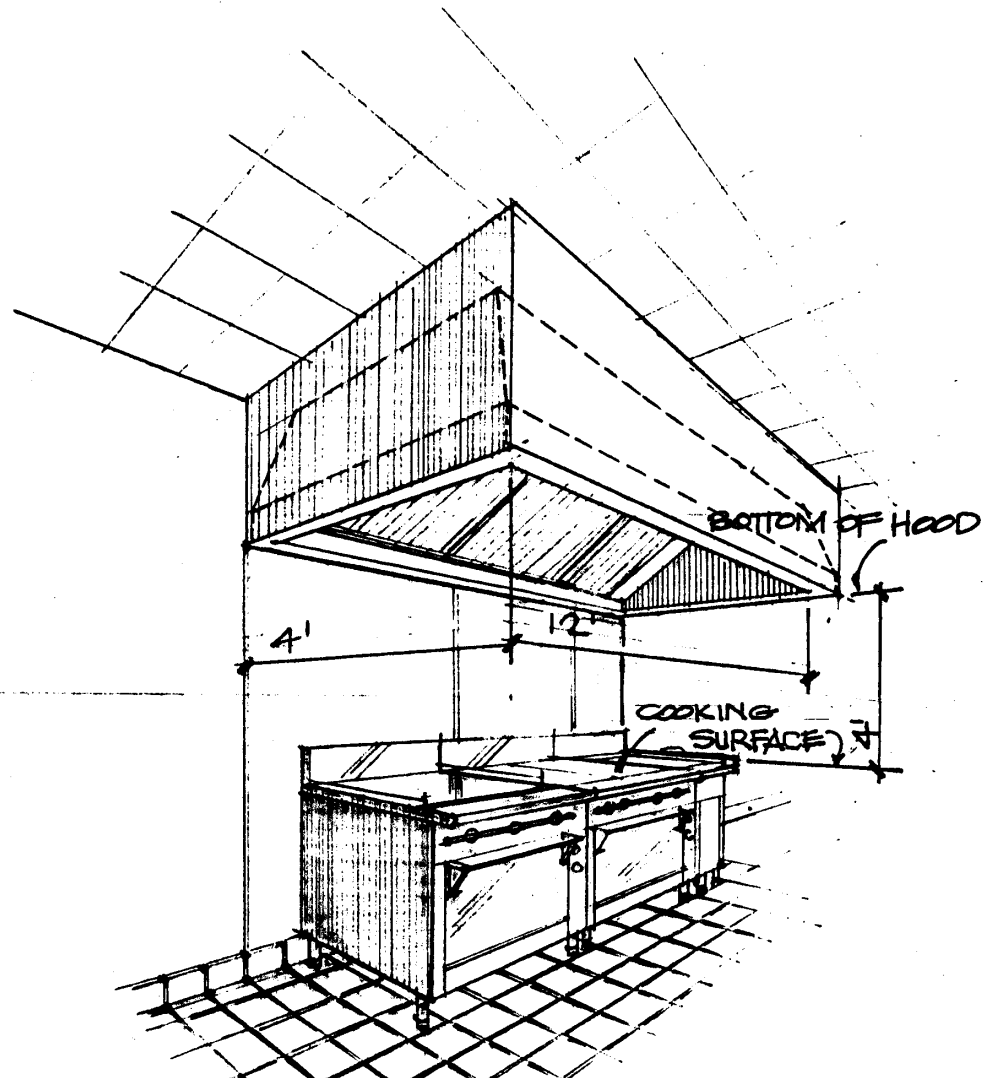
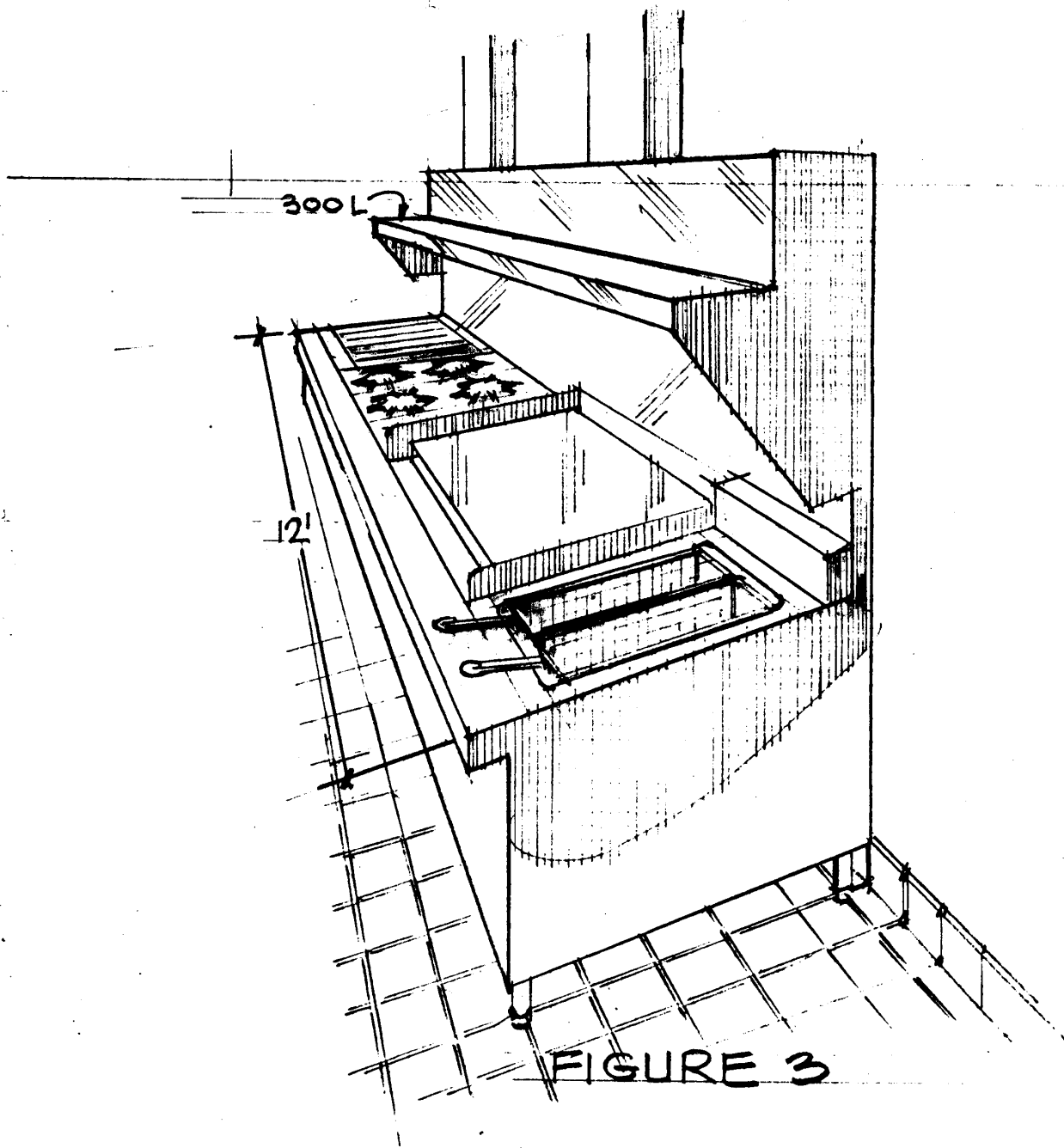

FIGURE 2



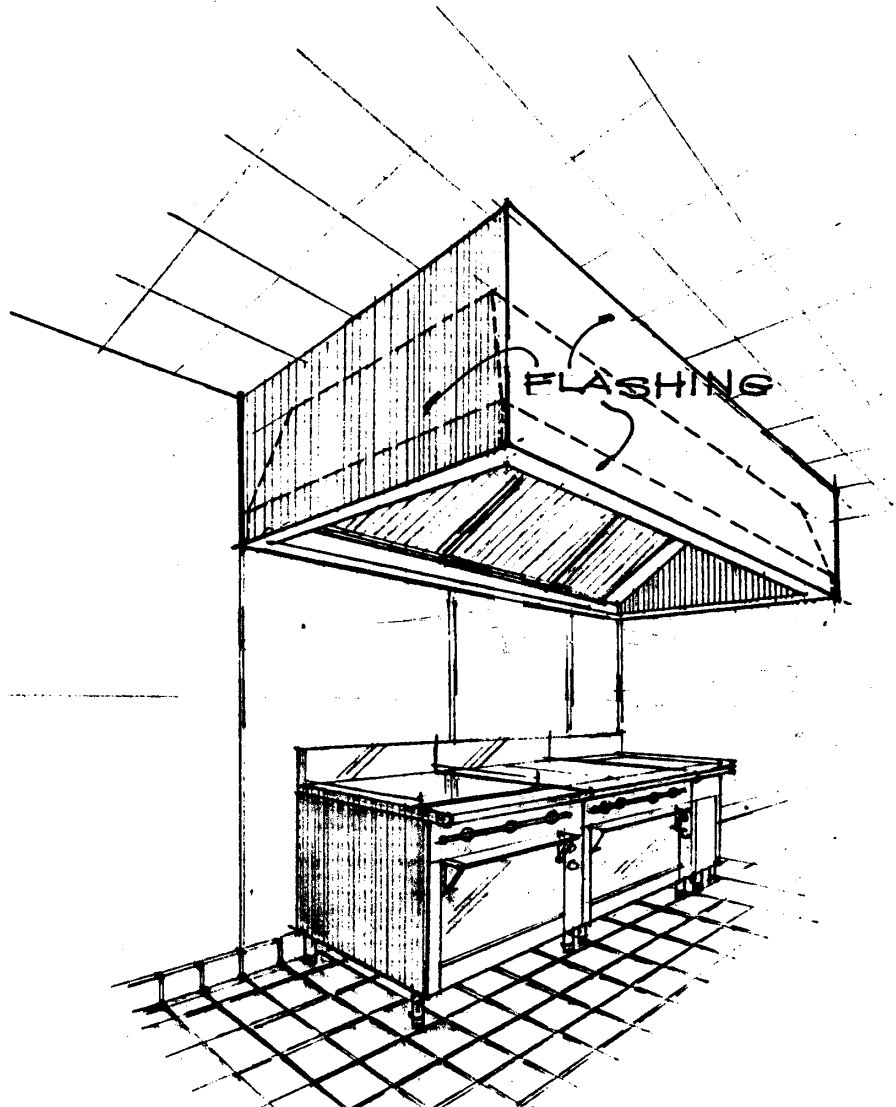

FIGURE 4

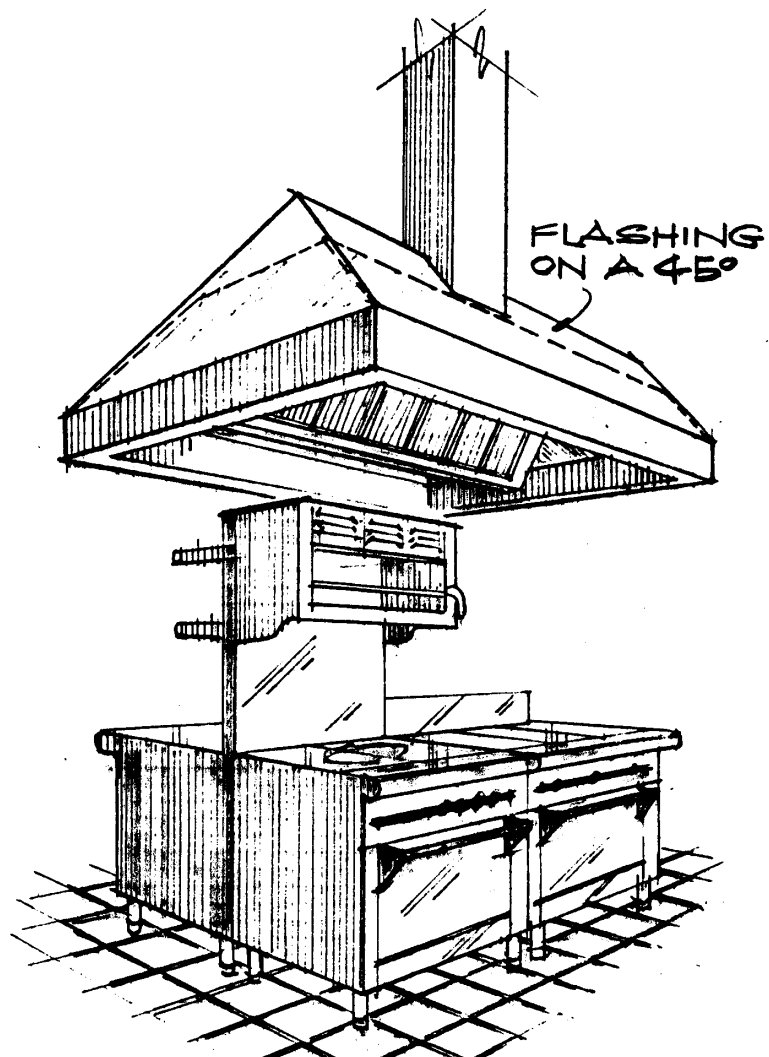

FIGURE 5

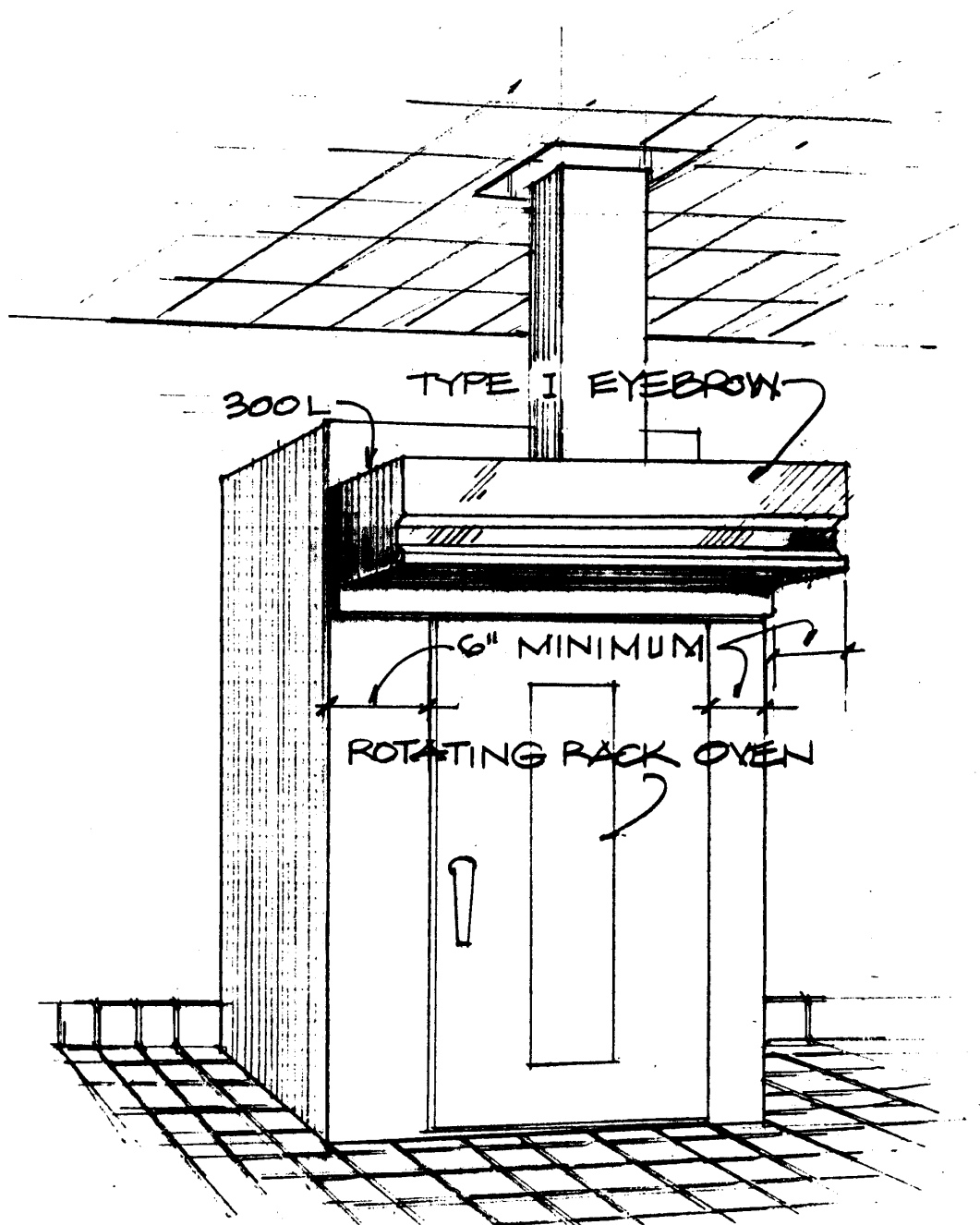

FIGURE 6

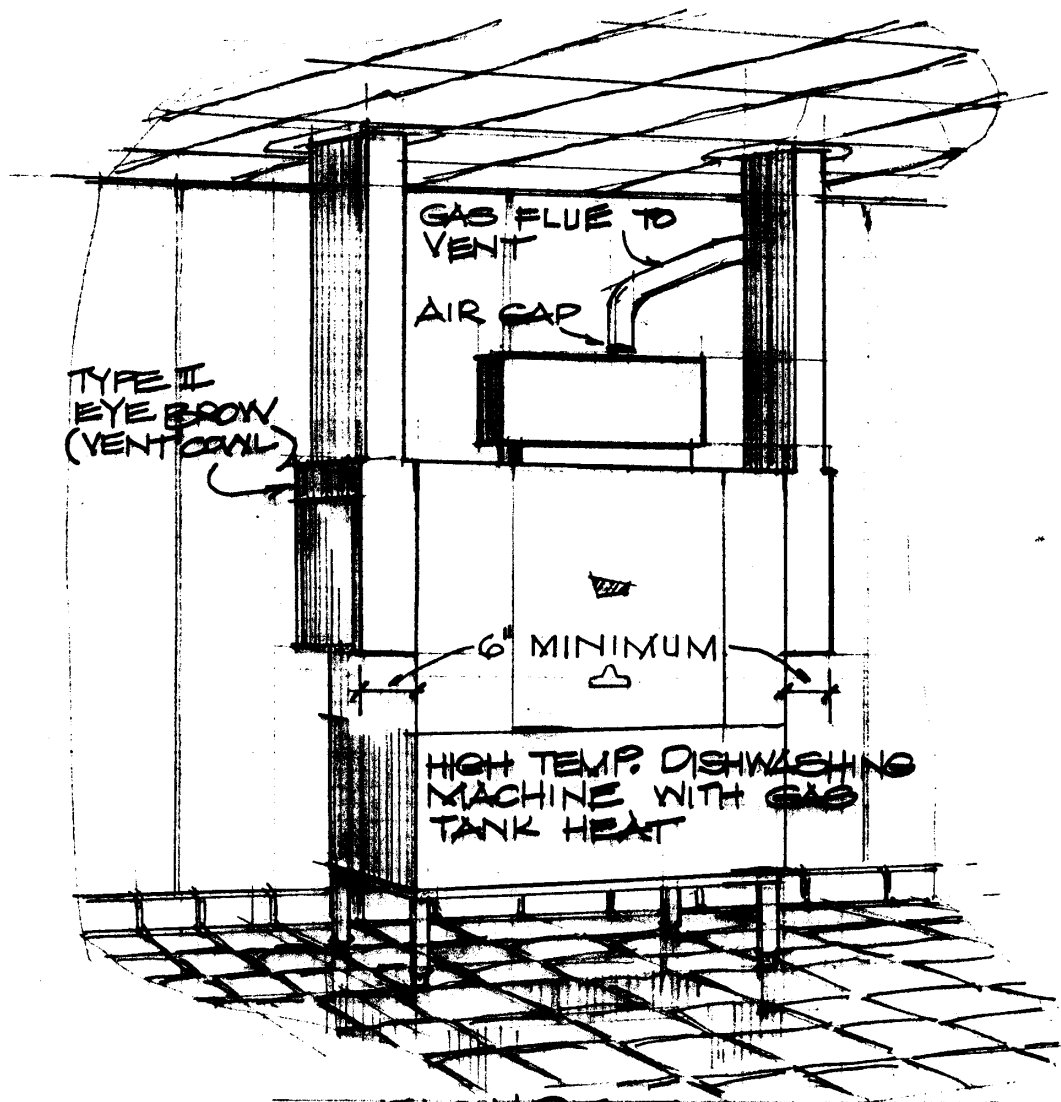

FIGURE 7

ATTACHMENT II

Guidelines for Sizing Water Heaters

GUIDELINES FOR SIZING WATER HEATERS

California Conference of Directors of Environmental Health
September, 1995

I. BACKGROUND

A critical factor in preventing foodborne illnesses in a food facility is the provision of an adequate supply of hot water for the washing of hands, utensils, equipment, and the facility itself. The installation of a properly sized water heater will ensure that a sufficient amount of hot water will be available at all times.

II. PURPOSE

The purpose of these guidelines is to provide a set of criteria that will assist architects, designers, contractors and owners in properly sizing water heaters to adequately meet the anticipated hot water demands of food facilities in California.

Food facilities with water heaters sized according to these criteria should be capable of complying with the requirements for providing an adequate hot water supply as required by the California Uniform Retail Food Facilities Law.

III. LEGAL AUTHORITY

California Health and Safety Code, Chapter 4, Article 8, Sections 27623, 27624, 27625, 27627, and 27627.3.

IV. DEFINITIONS

- **Booster Heater:** An instantaneous water heater designed and intended to raise the temperature of hot water to a higher temperature for a specific purpose, such as for the sanitizing rinse on a high temperature automatic dishmachine.
- **BTU (British Thermal Unit):** The quantity of heat required to raise the temperature of one pound of water one degree Fahrenheit.
- **GPH (Gallons Per Hour):** The amount of water, in gallons, that is used each hour by the plumbing fixtures and equipment, such as dishmachines.
- **GPM (Gallons Per Minute):** The amount of water, in gallons, flowing through a plumbing fixture or through an instantaneous water heater per minute.
- **Instantaneous Water Heater:** A water heater that generates hot water on demand.
- **KW (Kilowatt):** A unit of electric power equal to 1,000 watts.
- **Rise:** The temperature of water as it leaves the water heater minus the temperature of the water entering the water heater.
- **Storage Water Heater:** A water heater that incorporates a thermostat, a storage tank, and a burner or heating elements, to heat and maintain the water within the tank at a specific temperature.
- **Thermal Efficiency:** The measure of the overall efficiency of the water heater, taking

into consideration loss of energy due to combustion, radiation, convection and conduction of heat from the unit.

V. GENERAL REQUIREMENTS

- A. A water heater shall be provided which is **capable** of generating an adequate supply of hot water, at a temperature of at least 120° Fahrenheit, to all sinks, janitorial facilities, and other equipment and fixtures that use hot water, at all times.
- B. Water heaters and their installation must be in compliance with all local building code requirements.
- C. Water heaters that use reclaimed heat from equipment to heat water must be evaluated on a case by case basis.

VI. SIZING REQUIREMENTS FOR STORAGE WATER HEATERS

- A. For food facilities that utilize multiservice eating and drinking utensils, the water heater shall have a recovery rate equal to or greater than 100% of the computed hourly hot water demand, in gallons per hour (GPH).
- B. For food facilities that use only single-service eating and drinking utensils, or don't use utensils at all, the water heater shall have a recovery rate equal to or greater than 80% of the computed hourly hot water demand, in GPH.
- C. For food facilities that handle and sell **only** prepackaged foods, a water heater with a minimum storage capacity of ten gallons must be provided.
- D. The hourly hot water demand for the food facility, in GPH, is calculated by adding together the estimated hot water demands for all sinks and other equipment, such as dishmachines, which utilize hot water. The estimated hot water demands for sinks and other equipment that utilize hot water are listed in Appendix I. The hot water demands for automatic warewashers, such as dishmachines, glasswashers, and potwashers are found in NSF International listings or listings established by other nationally recognized testing laboratories.
- E. The following examples are provided to explain how to calculate the total hourly hot water demand:

- 1. Food facility that utilizes only single service eating and drinking utensils:

Assume:

1 18" X 18" three compartment sink	42 GPH
2 hand lavatories	10 GPH (5 GPH each)
1 janitorial sink	15 GPH
<hr style="border: 0.5px solid black;"/>	
	67 GPH total hourly hot water demand

67 GPH X 80% allowance for single service utensils = 54 GPH

For the food facility in this example, a water heater would be required which will recover 54 GPH.

2. Food facility that utilizes multiservice eating and drinking utensils:

Assume:

1 18" X 18" three compartment sink	42 GPH
automatic dishmachine	80 GPH
hand spray pre-rinse	45 GPH
one compartment food preparation sink	5 GPH
2 hand lavatories	10 GPH (5 GPH each)
1 janitorial sink	15 GPH
	197 GPH total hourly hot water demand

Since the food facility in this example uses multiservice eating and drinking utensils, 100% of the computed hourly hot water demand must be provided. Therefore, a water heater would be required which will recover 197 GPH.

F. To compute a BTU or KW rating for the required hourly hot water demand found in example #1 the following formulas should be used:

Formula 1 (for gas water heaters)

$$\frac{\text{BTU input}}{\text{Thermal Efficiency}^2} = \text{GPH} \times \text{°Rise}^1 \times 8.33 \text{ lb./gallon of water}$$

$$\frac{\text{BTU input}}{\text{.75}} = 54 \text{ GPH} \times 50\text{°F} \times 8.33 \text{ lb.}$$

$$\text{BTU input} = 29,988$$

¹ The average temperature of tap water varies throughout the State depending upon the location, elevation, and time of year. In order to properly size the water heater check with your local health agency to determine the required rise. For the purposes of these guidelines a tap water temperature of 70° Fahrenheit will be used. Therefore, to achieve a temperature of 120° Fahrenheit at the faucet, the required rise would be 50°.

² The thermal efficiency for gas water heaters, unless otherwise listed by NSF International or other nationally recognized testing laboratories, will be assumed to be 75%.

Formula 2 (for electric water heaters)

$$\frac{\text{KW input}}{\text{Thermal Efficiency}^1} \times 3412 \text{ BTU/KW} = \text{GPH} \times \text{°Rise} \times 8.33 \text{ lb./gallon of water}$$

$$\frac{\text{KW input}}{\text{.98}} \times 3412 \text{ BTU/KW} = 54 \text{ GPH} \times 50\text{°F} \times 8.33 \text{ lb.}$$

$$\text{KW input} = 6.7$$

¹ The thermal efficiency for electric water heaters, unless otherwise listed by NSF International or other nationally recognized testing laboratories, will be assumed to be 98%.

Sizing tables for gas and electric water heaters are found in Appendices II and III respectively.

VII. SIZING REQUIREMENTS FOR INSTANTANEOUS WATER HEATERS

- A. One of the advantages of an instantaneous water heater is its ability to provide a continuous supply of hot water. However, since the water passes through a heat exchanger, the water must flow through the unit slowly to ensure proper heat transfer. Therefore, the quantity, or rate, at which the hot water is delivered can be significantly less than that provided by a storage water heater. When hot water is utilized at several locations of the food facility at the same time the flow of hot water to each fixture can be severely restricted. As a result of the restricted output of instantaneous water heaters, more than one unit may be required, depending on the numbers and types of sinks and equipment present. Due to the limitations inherent in the design of instantaneous water heaters, some local health agencies may restrict or prohibit their usage. Check with your local health agency prior to installing an instantaneous water heater in order to determine their requirements.
- B. Instantaneous water heaters must be sized to provide hot water of at least 120° Fahrenheit, and at a rate of at least two gallons per minute (GPM), to each sink and fixture that utilizes hot water. (Note: Hand lavatories must receive at least 1/2 GPM.) The following example is provided to explain how this sizing criteria is applied:

Assume:

1 18" X 18" three compartment sink	2 GPM
2 hand lavatories	1 GPM (1/2 GPM each)
1 janitorial sink	2 GPM
	5 GPM

- C. In the example given above, one or more instantaneous water heaters would have to be provided in order to supply a total of at least 5 GPM.
- D. Food facilities that install an automatic warewashing machine that utilizes a large quantity of hot water may be required to provide an instantaneous water heater exclusively for the warewashing machine. NSF International listings or listings established by other nationally recognized testing laboratories are used to determine the minimum GPM hot water demand for automatic warewashing machines.

VIII. REQUIREMENTS FOR BOOSTER HEATERS

- A. When a hot water sanitizing warewashing machine is used, a booster heater must be provided that will raise the incoming general purpose hot water up to at least 180° Fahrenheit for the final sanitizing rinse cycle.
- B. When sizing a booster heater, the hot water demand for the warewashing final sanitizing rinse cycle should be obtained from the NSF International listings or listings established by other nationally recognized testing laboratories.
- C. The formulas for calculating BTU or KW input listed in section VI.F. should be used when determining the minimum required size for a booster heater.

- D. When a booster heater is installed below a drainboard, it shall be installed at least six inches above the floor and away from the wall, and in a manner that will allow accessibility for proper cleaning and servicing.

IX. RECIRCULATION PUMPS

- A. Where fixtures are located more than sixty feet from the water heater, a recirculation pump must be installed, in order to ensure that water reaches the fixture at a temperature of at least 120° Fahrenheit.
- B. In some cases it may be more practical to install a separate, smaller water heater for remote fixtures, such as for restroom handsinks.

X. INSTALLATION REQUIREMENTS

- A. Where feasible, water heaters should be located in an area of the food facility separated from all food and utensil handling areas.
- B. The Uniform Building Code prohibits the installation of gas water heaters in restrooms or change rooms.
- C. Water heaters shall be mounted in one of the following manners:
 - 1. On six inch high, easily cleanable legs.
 - 2. On a four inch high covered curb base. All openings between the water heater and the base must be sealed in a watertight manner.
 - 3. On a properly finished and installed wall pedestal, positioned so that it is out of the work and traffic space.
 - 4. In an easily accessible location above a suspended ceiling. Where a permanently installed ladder is required to access the water heater, the ladder shall not be installed above a food or utensil handling area.

Note: The local health agency may allow alternate installation methods when a water heater is installed in an area separated from food and utensil handling areas, such as in a mechanical room.

- D. A common mistake with electric water heaters is the ordering and installing of a water heater with an upper element of 4500 watts, a bottom element of 4500 watts, and a total connected (or maximum) wattage of 4500 watts. On such a water heater only one element is operating at any one time. Many individuals do not observe the total connected wattage and assume that because each of the elements is 4500 watts their water heater has an input rating of 9000 watts.

Water heater manufacturers have specific procedures for rewiring an electric water heater so that the upper and lower elements are operating simultaneously. Some manufacturers only permit rewiring in the factory. Field modifications will normally void warranties and any listings that the unit comes with. Prior to acceptance of a field modified water heater, the local health agency should ensure that the modifications were performed according to the manufacturer's recommendations and with the approval of the local building officials. The data plate on a field modified water heater

must be changed to reflect the total connected wattage rating with both elements operating simultaneously.

- E. When multiple water heaters are connected, they must be installed in parallel, not in series (See Appendix IV).

July 21, 1995

ATTACHMENT III

Safe Plumbing Practices

LOS ANGELES COUNTY - DEPARTMENT OF HEALTH SERVICES
 CROSS CONNECTION AND WATER POLLUTION CONTROL PROGRAM
 5050 COMMERCE DRIVE
 BALDWIN PARK, CA 91706 (626) 430-5290

SAFE PLUMBING PRACTICES

AIRGAP

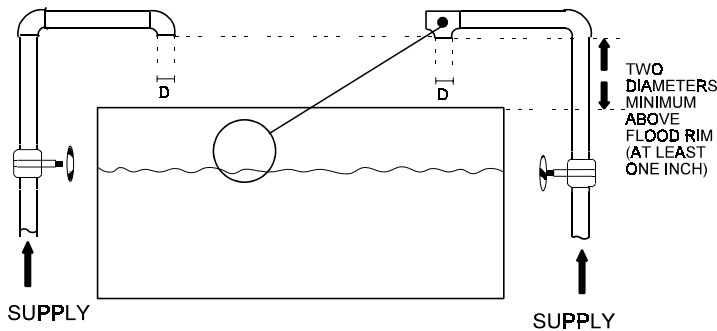

ATMOSPHERIC TYPE VACUUM BREAKER

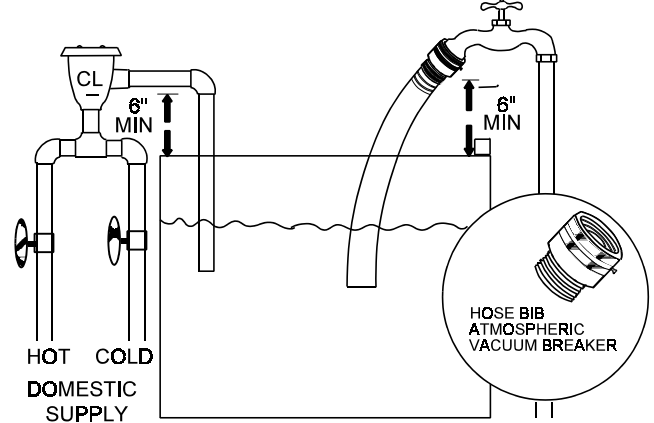

PRESSURE TYPE VACUUM BREAKER

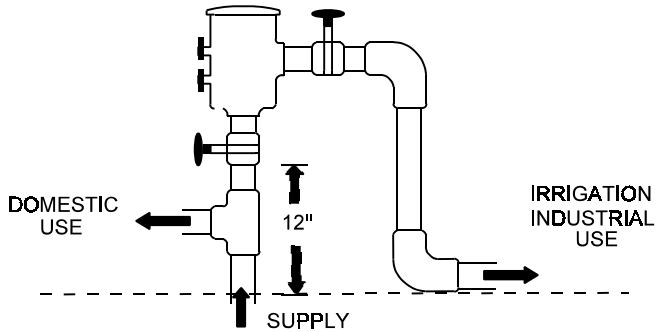

REDUCED PRESSURE PRINCIPLE BACKFLOW DEVICE

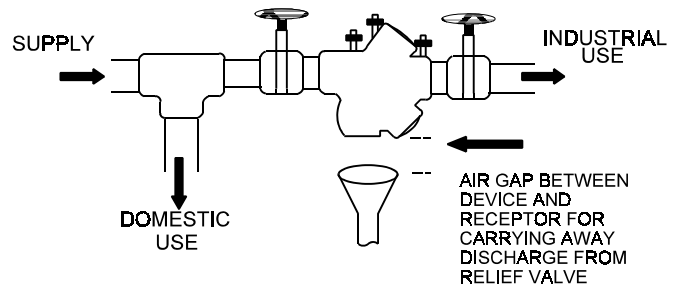

INSTALLATION REQUIREMENTS FOR BACKFLOW DEVICES

1. REDUCED PRESSURE PRINCIPLE DEVICE
 - a. at least 12 inches above grade.
 - b. in a horizontal position with the relief valve discharging downward.
 - c. readily accessible for inline service and test.
2. PRESSURE TYPE VACUUM BREAKER
 - a. at least 12 inches above all downstream piping and water use.
 - b. not subjected to any backpressure.
 - c. readily accessible for inline service and test.
3. ATMOSPHERIC TYPE VACUUM BREAKER
 - a. downstream of all valving.
 - b. at least 6 inches above all downstream piping and water use.
 - c. not subjected to backpressure.
 - d. not under more than 12 hours continuous flow.
4. DOUBLE CHECK VALVE ASSEMBLIES
 - a. at least 12 inches above grade.
 - b. in a horizontal position
 - c. readily accessible for inline service and test.

Note: Double check valve assemblies have very limited application. Water connections to looped domestic services, certain fire systems and meter service protection are examples of where they may be permitted.

OTHER REQUIREMENTS

1. Domestic water is required at all sanitary facilities, drinking fountains, emergency eyewash stations and safety showers.
2. All industrial water piping and outlets must be identified to clearly distinguish them from domestic water systems.
3. Quick couplers must be installed downstream of an approved reduced pressure principle device or pressure type vacuum breaker.
4. New testable backflow devices are to be tested upon installation by a certified backflow device tester and a report filed with this office. Thereafter, each device must be tested on an annual basis.
5. Technical assistance regarding backflow protection device installation and testing is available by calling (323) 881-4140.

Note: As the department having jurisdiction, this Department shall rule what is acceptable as "readily accessible for service and test". Device installation above false ceilings, within confined spaces, or where flooding may occur are unacceptable.

FIXED AIRGAP

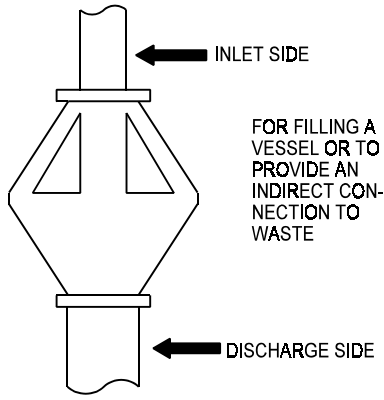

BALLCOCK ASSEMBLY

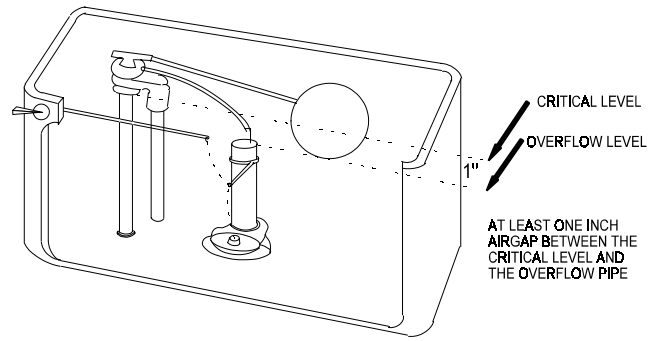

REDUCED PRESSURE PRINCIPLE BACKFLOW DEVICE

- FERTILIZER INJECTION SYSTEM
- QUICK COUPLER VALVE
- SLOPE IRRIGATION
- UP FEED

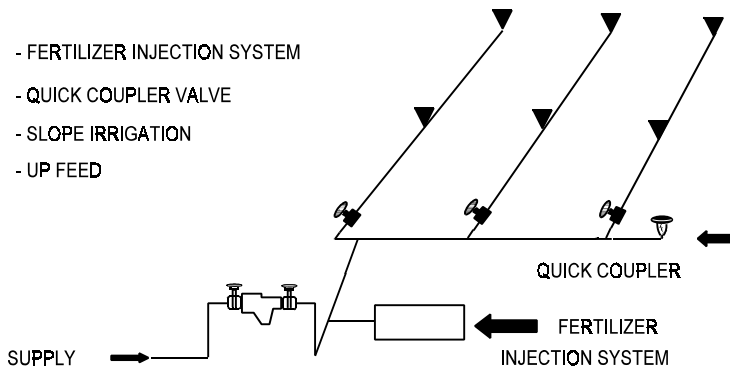

FLUSHOMETER VALVE

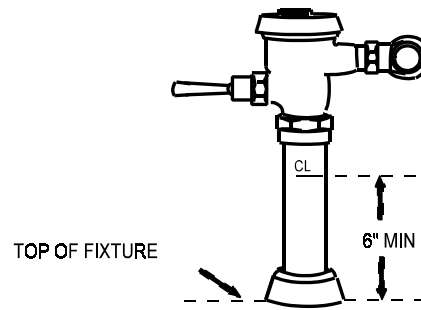

COMBINATION VALVE

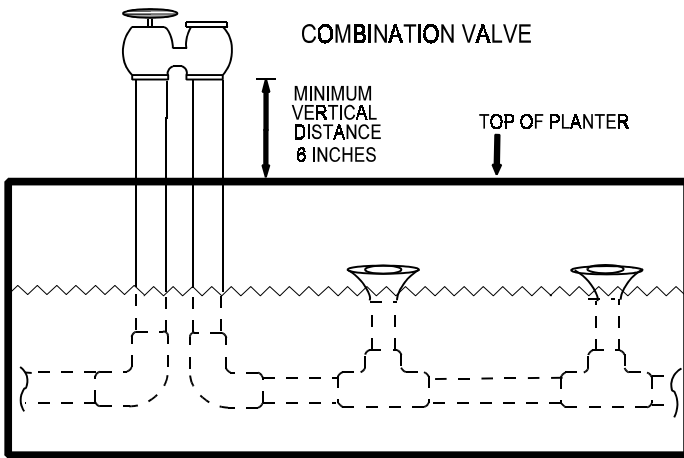

PRESSURE TYPE VACUUM BREAKER

- SLOPE IRRIGATION
- DOWN FEED OR LEVEL
- DOWNSTREAM VALVING
- QUICK COUPLER

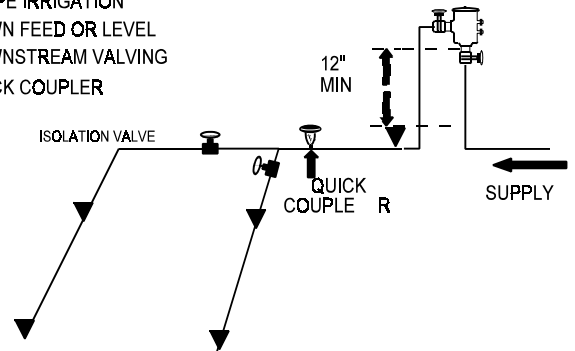

ATMOSPHERIC TYPE VACUUM BREAKER

- SLOPE IRRIGATION
- DOWN FEED OR LEVEL
- NO DOWNSTREAM VALVING

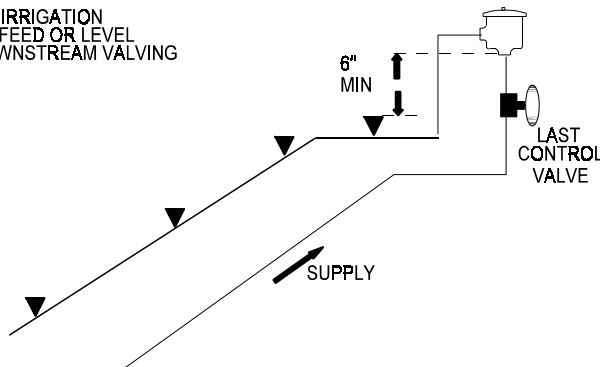

LOOPED IRRIGATION SYSTEMS

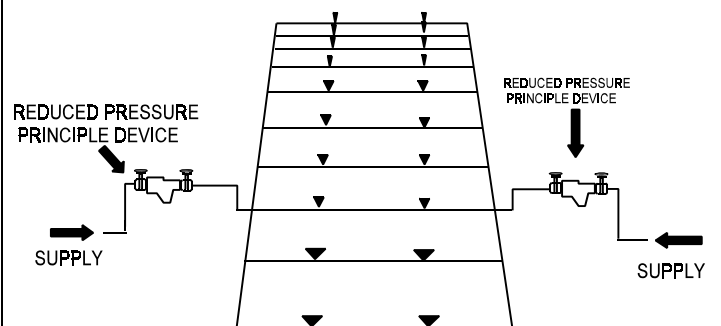



What You Need to Know About **REGISTRATION OF FOOD FACILITIES**

FDA Food Security Information for Domestic and Foreign:

- ▶ **Manufacturers or Processors**
- ▶ **Packers**
- ▶ **Holding Facilities**

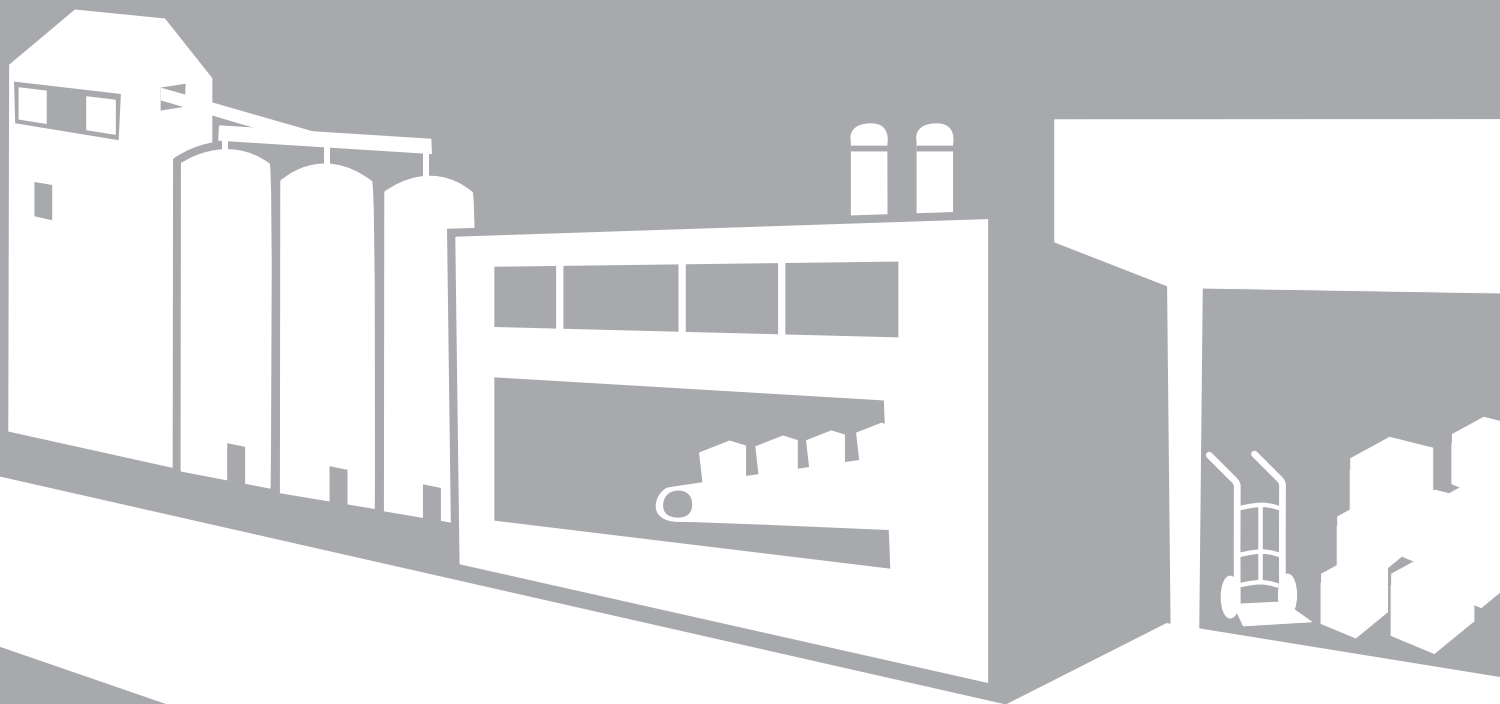

The Public Health Security and Bioterrorism
Preparedness and Response Act of 2002

November 2003



U.S. Food and Drug
Administration



U.S. Department of Health
and Human Services

This guidance document is a restatement of the Food and Drug Administration's (FDA's) current requirements for registration of food facilities presented in simplified format and language. As guidance, it is not binding on either FDA or the public. FDA notes, however, that the regulation that is the basis for this pamphlet establishes requirements for all covered activities. For this reason, FDA strongly recommends that affected parties consult the regulation at 21 CFR Part 1, Subpart H, in addition to reading this pamphlet.

The Food and Drug Administration has prepared this guidance to restate the legal requirements set forth in 21 CFR 1.225 through 1.243 concerning registration of food facilities under the Public Health Security and Bioterrorism Preparedness and Response Act of 2002. This guide is intended to help any entity, regardless of size, to comply with the regulations that require domestic and foreign facilities that manufacture/process, pack, or hold food for human or animal consumption in the United States to register with FDA. This document also serves as FDA's Small Entity Compliance Guide (SECG), in accordance with section 212 of the Small Business Regulatory Enforcement Fairness Act (Public Law 104-121).

The Public Health Security and Bioterrorism Preparedness and Response Act of 2002 (the Bioterrorism Act) directs the Food and Drug Administration (FDA), as the food regulatory agency of the Department of Health and Human Services, to take additional steps to protect the public from a threatened or actual terrorist attack on the U.S. food supply and other food-related emergencies.

To carry out certain provisions of the Bioterrorism Act, FDA has established new regulations requiring that:

- Food facilities are registered with FDA, and
- FDA be given advance notice on shipments of imported food.

These regulations go into effect on December 12, 2003.

Purpose of this Booklet

This booklet was created to inform domestic and foreign food facilities about the new food facility registration law and regulations. It contains important information that may affect your firm.

The information in this booklet also appears online at <http://www.fda.gov/oc/bioterrorism/bioact.html>.

ABOUT REGISTRATION

Food Facility Registration Requirement

Domestic and foreign facilities that manufacture, process, pack, or hold food, as defined in the regulation, for human or animal consumption in the U.S. must register with FDA by December 12, 2003.

Why Registration Is Required

Food facility registration will help FDA to:

- Determine the location and source of a potential bioterrorism incident or an outbreak of food-borne illness; and
- Quickly notify facilities that may be affected.

What It Costs

There is no fee for registration or updates to a registration.

HOW REGISTRATION AFFECTS YOU

Which Facilities Must Register

If your facility is in one of following food industry sectors, you must register your facility with FDA by December 12, 2003.

Food Industry Sectors Affected

- Domestic and foreign manufacturers or processors*
- Domestic and foreign packers*
- Domestic and foreign storage operations *

Foods Handled by More Than One Foreign Facility

If...	Then...
A foreign facility that manufactures, processes, packs, or holds food sends it to another foreign facility for further manufacturing/processing or packaging before the food is exported to the U.S.	Only the second foreign facility is required to register.
The second foreign facility performs only a minimal activity, such as putting on a label	Both facilities must register.
Any foreign facility packs or holds food after the last foreign manufacturer/processor of the food	The foreign packer or holder must register.

* Domestic facilities must register whether or not food from the facility enters interstate commerce.

Food Included in the Regulation

Registration pertains only to facilities that manufacture/process, pack, or hold food, as defined in the regulation, for consumption by humans or animals in the U.S.

The following chart gives examples of the types of food that are included in or excluded from the “food” definition in the facility registration regulation. If your facility handles ANY of the included foods, it must be registered.

INCLUDED Food	EXCLUDED Food
<ul style="list-style-type: none">• Dietary supplements and dietary ingredients• Infant formula• Beverages (including alcoholic beverages and bottled water)• Fruits and vegetables• Fish and seafood• Dairy products and shell eggs• Raw agricultural commodities for use as food or components of food• Canned and frozen foods• Bakery goods, snack food, and candy (including chewing gum)• Live food animals• Animal feeds and pet food	<ul style="list-style-type: none">• Food contact substances• Pesticides

Note: A facility that manufactures/processes, packs, or holds a food contact substance or pesticide is NOT required to register with FDA.

Facilities That Do Not Have to Register

If your facility is involved in one of the following activities, it does NOT have to register with FDA.

These Facilities DON'T Have to Register

- **Private residences of individuals**, even though food may be manufactured/processed, packed, or held in them.
- **Non-bottled water drinking water collection and distribution establishments and structures**, such as municipal water systems.
- **Transport vehicles that hold food only in the usual course of their business as carriers.**
- **Farms** — i.e., facilities in one general location devoted to growing and harvesting crops (washing, trimming outer leaves, and cooling produce are part of harvesting) and/or raising animals (including seafood). The term “farm” also includes facilities that manufacture/process, pack, or hold food, provided that all food used in those activities is grown, raised, or consumed on that farm or another farm under the same ownership.
- **Restaurants** — i.e., facilities that prepare and sell food directly to consumers for immediate consumption, including pet shelters, kennels, and veterinary facilities that provide food directly to animals. Facilities that provide food to interstate conveyances, such as commercial aircraft, or central kitchens that do not prepare and serve food directly to consumers, are not restaurants for purposes of the rule.
- **Retail food establishments**, such as groceries, delis, and roadside stands, that sell food directly to consumers as their *primary function*, meaning that annual food sales directly to consumers are of greater dollar value than annual sales to other buyers.
- **Nonprofit food facilities**, which are charitable entities that meet the terms of § 501(c)(3) of the Internal Revenue Code and that prepare or serve food directly to the consumer or otherwise provide food or meals for consumption by humans or animals in the U.S. This includes central food banks, soup kitchens, and nonprofit food delivery services.
- **Fishing vessels that harvest and transport fish.** Such vessels may engage in practices such as heading, eviscerating, or freezing fish solely to prepare the fish for holding on board the vessel and remain exempt.
- **Facilities regulated exclusively and throughout the entire facility by the U.S. Department of Agriculture**, that is, facilities handling only meat, poultry, or egg products.

When Your Facility Must Register

The deadline to register your facility with FDA is December 12, 2003.

Facilities that go into business after December 12, 2003, must register before they begin manufacturing/processing, packing, or holding operations.

How Often Your Facility Must Register

Registration is required only once for each food facility. However, if required registration information about your facility changes, you must update the registration.

Who May Register

The owner, operator, or agent in charge of a facility, or an individual authorized by one of them, may register that facility.

Foreign facilities must designate a U.S. agent, who lives or maintains a place of business in the U.S. and is physically present in the U.S., for purposes of registration. The U.S. agent may be authorized to register the facility.

What If Your Facility Fails to Register

Failure to register your facility, update required elements, or cancel registration in accordance with this regulation is a prohibited act under the Federal Food, Drug, and Cosmetic Act. The Federal government can bring a civil action against persons who commit a prohibited act, or it can bring a criminal action in Federal court to prosecute persons who are responsible for the commission of a prohibited act, or both.

If a foreign facility is required to register but fails to do so, food from that facility that is offered for import into the U.S. is subject to refusal. The food may be held within the port of entry, unless directed elsewhere by FDA or the Customs and Border Protection Service (CBP).

FDA plans to issue enforcement guidance on the agency's policies regarding refusals of imported food or holds of imported food. This guidance document will be available to the public, and FDA will publish a notice of its availability in the Federal Register.

REGISTERING YOUR FACILITY

How to Register Your Facility

Registrants must use Form 3537 to register or update a registration. This form is available online and in paper form. A business with multiple facilities may also register on CD-ROM. FDA will process paper and CD-ROM submissions in the order received.

Note: FDA does not allow registration in person.



Online Registration

You can save time by registering online at <http://www.access.fda.gov/>. This web site offers online help and operates 24 hours a day, seven days a week. You can access the site wherever the Internet is available — including libraries, copy centers, schools, and Internet cafes.

An Online Registration Help Desk is available on business days, from 7:00 AM until 11:00 PM U.S. Eastern Standard Time to help you.

To Contact the Online Registration Help Desk:

By phone	WITHIN THE U.S.: Call 1-800-216-7331 or 301-575-0156 OUTSIDE THE U.S.: Call 301-575-0156
By fax	Fax questions to 301-210-0247
By email	Go to http://www.cfsan.fda.gov/~furls/helpf2.html and complete the form



Paper Registration

If your facility does not have reasonable access to the Internet, you can request a copy of **Form 3537** from FDA by mail or phone. The form can be mailed or faxed to you.

To Request the Form:

By mail	Write to: U.S. Food and Drug Administration HFS-681 5600 Fishers Lane Rockville, MD 20857 USA
By phone	Call 1-800-216-7331 or 301-575-0156 (7:00 a.m. to 11:00 p.m. U.S. Eastern Standard Time)

Fill out the form completely and legibly and mail it to the above address, or fax it to **301-210-0247**.

Note: Paper registration is less efficient than online registration. It takes longer to receive confirmation for paper registration. And, if your form contains omissions or errors, FDA will return it for corrections without registering your facility — resulting in further delay.



CD-ROM Registration

If your business has a large number of food facilities, you may wish to submit multiple registrations on a CD-ROM by mail. You can do so, provided that each registration uses the same preferred mailing address. The CD-ROM you use must have ISO 9660 (CD-R or CD-RW) data format.

To Register by CD-ROM:

1. Go to <http://www.cfsan.fda.gov/~furl/papercd.html> and download the Portable Document Format (PDF) version of **Form 3537**.
2. Fill in a separate copy of the form electronically for each facility.
3. Use the same preferred mailing address for each facility.
4. Save the form for each facility under a different file name:
 - a. The file name can be up to 32 characters long.
 - b. Use the first part of the file name to identify the parent company.
5. Copy the files to a CD-ROM with ISO 9660 (CD-R or CD-RW) data format.
6. Enclose one signed copy of the certification statement that appears on the registration form (Box 13).
7. Mail the CD-ROM to:

U.S. Food and Drug Administration
HFS-681
5600 Fishers Lane
Rockville, MD 20857

Note: If you send a CD-ROM that does not comply with the above specifications, FDA will return it without processing, which will delay registration.

Information Required for Registration

FDA requires you to provide the following information for facility registration.

Required Information

- Facility name, address, phone number, and emergency contact phone number
- Parent company name, address, and phone number (if applicable)
- Name, address, and phone number of the owner, operator, or agent in charge
- All trade names the facility uses
- Applicable food product categories, as listed on the registration form
- Name, address, and phone number of a foreign facility's U.S. agent, and phone number of the facility's emergency contact if it is someone other than the U.S. agent
- Certification that the information submitted is true and accurate and that the person submitting it is authorized to do so

Optional Registration Information

FDA also requests optional registration information. Although you are not required by law to comply with this request, FDA encourages you to do so — particularly if your facility handles products such as infant formula, certain dietary supplements, and animal feed — as those products may be the target of a food-related emergency.

Optional Information Requested

- Facility fax number and email address
- Preferred mailing address, if different from that of the facility
- Fax number and email address of the owner, operator, or agent in charge of the facility
- Fax number and email address of the parent company (if applicable)
- For a foreign facility: the fax number and email address of its U.S. agent
- Type of activity conducted at the facility (i.e., processing, packing, etc.)
- Food categories not included in the required information; these are listed in section 11a of Form 3537 (where they are marked optional), or in section 11b (where all food categories listed are optional)
- Type of storage (if it's a holding facility)
- Whether the facility manufactures/processes, packs, or holds most or all of the product categories identified in 21 CFR 170.3
- Approximate dates of operation (if the facility's business is seasonal)

Facility Registration Screen

Here is a sample screen from the FDA registration web site (<http://www.access.fda.gov/>).

FFRM Food Facility Registration Module |  » FURLS Home
» FFRM Home

Step 01 Step 02 Step 03 Step 04 Step 05 Step 06 Step 07 Step 08

Get Help ?

<< Back to Step 01 >> Continue
<< Cancel & Start Again From Section 1

SECTION 2 FACILITY NAME / ADDRESS INFORMATION

*** - These fields are required**

>> AutoFill Address >> Clear

*FACILITY NAME
*FACILITY STREET ADDRESS, Line1
FACILITY STREET ADDRESS, Line2
*CITY
*COUNTRY
United States
*STATE/PROVINCE/TERRITORY
[Please Select]
*ZIP CODE (POSTAL CODE)

Numbers only. No spaces, dashes or parentheses. Country Code not required for US phone numbers.

	Country Code (e.g.033)	Area/City Code (e.g.101)	Phone Number (e.g.5551111)	Extension (e.g.1111)
*PHONE	<input type="text"/>	<input type="text"/>	<input type="text"/>	<input type="text"/>

	Country Code (e.g.033)	Area/City Code (e.g.101)	Fax Number (e.g.5551111)
FAX NUMBER	<input type="text"/>	<input type="text"/>	<input type="text"/>

E-MAIL ADDRESS

SECTION 3 OPTIONAL: PREFERRED MAILING ADDRESS INFORMATION
(complete this section only if different from Section 2, Facility Name/Address Information)

***** - This section is optional. If you intend to complete this section, the fields marked with *** are necessary for the system to process a complete response**

>> AutoFill Address >> Clear

Autofill Address will fill the address fields automatically using data in Section 3 from the last registration entered

***NAME
***ADDRESS, Line1
ADDRESS, Line2
***CITY
***COUNTRY
[Please Select]
***STATE/PROVINCE/TERRITORY
[Please Select a Province]
***ZIP CODE (POSTAL CODE)

Numbers only. No spaces, dashes or parentheses. Country Code not required for US phone numbers.

	Country Code (e.g.033)	Area/City Code (e.g.101)	Phone Number (e.g.5551111)	Extension (e.g.1111)
***PHONE NUMBER	<input type="text"/>	<input type="text"/>	<input type="text"/>	<input type="text"/>

	Country Code (e.g.033)	Area/City Code (e.g.101)	Fax Number (e.g.5551111)
FAX NUMBER	<input type="text"/>	<input type="text"/>	<input type="text"/>

E-MAIL ADDRESS

<< Back to Step 01 >> Continue
<< Cancel & Start Again From Section 1

How Registration Is Confirmed

After you register your facility, FDA will confirm the registration and assign a registration number.

If You Register...	You Will Receive Confirmation
Online	Immediately — electronically
By fax	By fax
By surface mail or CD-ROM	By surface mail

Note: Assignment of a registration number means only that the facility is registered. It does NOT convey FDA approval or endorsement of the facility or its products.

Confidentiality of Registration Information

The list of registered facilities and submitted registration documents are not subject to disclosure under the Freedom of Information Act. This confidentiality does not apply to information obtained by other means or that has previously been disclosed to the public.

How to Update Registration Information

If any of the required information on your registration form changes — for example, if there is a new operator, agent in charge, or U.S. agent — the owner, operator, or agent in charge, or an individual authorized by one of them, must notify FDA within 60 days.

You can submit information changes online (regardless of how you originally registered), by paper, or on CD-ROM.

To Update Your Registration:	
Online	Go to http://www.access.fda.gov/ *
By paper	Use the paper registration process described on page 8
By CD-ROM	Enter the changes on CD-ROM (see page 8)

In the case of new ownership, the former owner must cancel the facility's registration within 60 days and the new owner must register the facility before beginning operations.

How to Cancel Registration

If your facility goes out of business or comes under new ownership, you must cancel its registration within 60 days using Form 3537a. You can do this electronically at <http://www.access.fda.gov/>, or you can request the form from FDA and use the paper registration process described on page 8.

* Use the PIN that was issued with your facility's registration number. If you originally registered by paper or CD-ROM, you will need to follow the online instructions to set up an account.

How to Comment on the Regulation

The registration regulation is currently an interim final rule. This means the regulation has the full force of law, but FDA is providing a 75-day comment period (ending December 24, 2003) on specific issues related to it. In addition, to ensure that those commenting on this interim final rule have had the benefit of FDA's outreach and educational efforts and have had experience with the systems, timeframes, and data elements of this interim final rule, the agency intends to reopen the comment period for an additional 30 days, beginning in March, 2004.

How to Get More Information

Additional information is available at <http://www.fda.gov/oc/bioterrorism/bioact.html>.

For more details and information on the specific requirements of the facility registration regulation, please refer to the **Fact Sheet on FDA's New Food Bioterrorism Regulation: Interim Final Rule — Registration of Food Facilities**. This fact sheet is available online at <http://www.cfsan.fda.gov/~dms/fsbtac12.html>.

WHAT It Is: Domestic and foreign facilities that manufacture, process, pack, or hold food, as defined in the regulation, for human or animal consumption in the U.S. must register with FDA by December 12, 2003.

WHY It's Required: To help FDA to determine the location and source of a potential or actual bioterrorism incident or an outbreak of food-borne illness, and permit the agency to notify quickly facilities that may be affected.

WHICH Facilities Must Register: Domestic and foreign manufacturers/processors, packers, and storage operations that handle foods included in the regulation.

Examples of WHICH Foods Require Facility Registration:

- Dietary supplements and dietary ingredients
- Infant formula
- Beverages (including alcoholic beverages and bottled water)
- Fruits and vegetables
- Fish and seafood
- Dairy products and eggs
- Raw agricultural commodities for use as food or components of food
- Canned and frozen foods
- Bakery goods, snack food, and candy (including chewing gum)
- Live food animals
- Animal feeds and pet food

WHEN Facilities Must Register: By December 12, 2003.

WHO May Register: The owner, operator, or agent in charge of a facility, or an individual authorized by one of them, may register that facility.

Foreign facilities must designate a U.S. agent, who lives or maintains a place of business in the U.S. and is physically present in the U.S., for purposes of registration. The U.S. agent may be authorized to register the facility.

HOW to Register:

Online	Go to http://www.access.fda.gov/ (24 hours a day, 7 days a week).
By Mail or Fax	<ol style="list-style-type: none"> 1. Request Form 3537 from FDA (1-800-216-7331 or 301-575-0156). 2. Mail or fax the completed form to: U.S. Food and Drug Administration HFS-681 Fishers Lane Rockville, MD 20857 U.S.A. Fax: 301-210-0247
On CD-ROM <small>(For multiple facilities using the same mailing address)</small>	<ol style="list-style-type: none"> 1. Download Form 3537 at http://www.cfsan.fda.gov/~furls/papercd.html. 2. Create separate electronic files for each facility. 3. Submit files on CD-ROM (ISO 9660 CD-R or CD-RW format). 4. Include a signed certification statement. 5. Send to the above address.

Get HELP: (business days, 7:00 AM to 11:00 PM U.S. EST)	
By phone	WITHIN THE U.S.: Call 1-800-216-7331 or 301-575-0156 OUTSIDE THE U.S.: Call 301-575-0156
By fax	Fax questions to 301-210-0247
By email	Go to http://www.cfsan.fda.gov/~furls/helpf2.html and complete the form

WHAT Information is Required:
<ul style="list-style-type: none"> • Facility name, address, phone number, and emergency contact phone number • Parent company name, address, and phone number (if applicable) • Name, address, and phone number of the owner, operator or agent in charge • All trade names the facility uses • Applicable food product categories, as specified in FDA regulation 21 CFR 170.3 • Name, address, phone number, and emergency contact phone number of a foreign facility's U.S. agent • Certification that the information submitted is true and accurate and that the person submitting it is authorized to do so

HOW Registration Is Confirmed: FDA confirms the registration either electronically (online registration) or by mail (paper or CD-ROM registration), and assigns a registration number.

What If ...

IF...	Then...
Required registration info changes	You must notify FDA within 60 days (online or by mail or fax).
There's a change in ownership	The former owner must cancel registration within 60 days and the new owner must re-register.
Your facility goes out of business	You must cancel registration.
A domestic facility fails to register	The Federal government can bring a civil or criminal action against the owner, operator, or agent in charge. However, FDA will use discretion in enforcing the regulation during the comment period (see below).
A foreign facility fails to register and then tries to import food into the U.S.	The food will be held at the port of entry, unless otherwise directed by FDA or CBP.

Comments and Compliance

FDA will provide a 75-day comment period (ending December 24, 2003) on issues related to this regulation. For the 4 months following December 12, 2003, FDA plans to focus on education and training to assist facilities required to register to comply with the rule. FDA will use discretion in enforcing the regulation, while at the same time ensuring public health protection.

Get More Info: For more information, go to <http://www.fda.gov/oc/bioterrorism/bioact.html>.



U.S. Department of Health and Human Services
U.S. Food and Drug Administration



For more information, go to
<http://www.fda.gov/oc/bioterrorism/bioact.html>



U.S. Food and Drug
Administration



U.S. Department of Health
and Human Services

November 2001

**INTERIM GUIDANCE FOR FOOD AND
AGRICULTURE SAFETY
AND SECURITY IN CALIFORNIA**



CALIFORNIA DEPARTMENT OF HEALTH SERVICES
FOOD AND DRUG BRANCH

INTERIM GUIDANCE FOR FOOD AND AGRICULTURE SAFETY AND SECURITY

November 2001

BACKGROUND

The potential for contamination of our food supply has always been present. The food industry has responded with sound food production, processing and distribution practices to minimize this threat. Now a rise in terrorism has increased the potential for food contamination¹. Sound security practices are needed to minimize this threat to public safety and the food industry. The security practices listed below are recommended for all food operations; the attached checklist offers more specific suggestions that may not always be appropriate or even feasible for your food operations. The goal of these security practices is to reduce the likelihood of a terrorist attack on your operations and to reduce a successful attack's impact to you, your business partners and the public. While the terrorist risk to an individual business is low, sound security practices represent good public health and smart business sense.

We recommend that you consider any trusted employees as your advisors in designing and implementing new security practices. The "ownership" of your practices by employees will be your most valuable line of defense.

IDENTIFY SECURITY WEAK SPOTS

Identify the Weak Spots

The initial step is to identify the security weak spots for each activity or step in the process of food preparation. To understand the flow of events in food production, it is helpful to first list the sequence for food preparation.

Identify the Resulting Hazards

Once the security weak spots have been identified consider the risk of each resulting hazard. Risk is the probability and severity of loss or negative impact to the food product from exposure to the hazard.

Put yourself in the role of a dedicated terrorist considering an attack on your operations and then review your entire operation from beginning to end. Ask yourself "What if..." type questions and think "outside the box".

¹ The Center for Counterproliferation Research reported that over 1/3 of the 16 confirmed cases of bioterrorism and 31 confirmed biocrimes committed in the U.S. (prior to 1999) involved food or other agricultural products.

INTERIM GUIDANCE FOR FOOD AND AGRICULTURE SAFETY AND SECURITY

November 2001

Identify points at which unauthorized persons have easy access to your facilities (e.g. via unlocked gates, doors or trucks) and those of your vendors and shippers.

Identify points at which the employees of your vendors, shippers and other businesses you regularly interact with have unnecessary access to a critical part of your operations.

Identify points at which your employees have unnecessary access to a critical part of your operations.

Identify methods by which any person could introduce, store or move unauthorized materials within your operations.

Identify any record “gaps” in the documentation of your product’s production, processing and distribution history.

Identify situations in which a terrorist act at or by a supplier, vendor or shipper could impact your operations (e.g., delivery of contaminated ingredient, contamination of your product during shipping).

Assess the food security awareness and commitment of your employees.

DEVELOP AND IMPLEMENT PRACTICES TO FEASIBLY STRENGTHEN AS MANY WEAK SPOTS AS POSSIBLE

Analyze Risk Control Measures

Examine risk control measures for the possible hazards that could be introduced into the operation. Identify and explore specific options and tools that reduce, or eliminate risk. Prioritize the risks and starting with the highest risk identify as many risk control options as possible. To identify an effective control measure it will reduce or eliminate one of the three risk components (probability, severity, or exposure). Other things to consider include the risk control costs and how various risk control options work together.

Make Control Decisions

There are several important points to keep in mind when making a risk control decision. Involve the employees who would be impacted by the risk control decision to the maximum extent in the selection. They can almost always provide ideas to enhance the various options. In addition, be sure to carefully evaluate the impact on the operation of the risk control action. The objective is to choose the option that has the best overall favorable impact on the operation. Once the best possible set of risk control options has been selected, the individual in charge must accept this decision.

INTERIM GUIDANCE FOR FOOD AND AGRICULTURE SAFETY AND SECURITY

November 2001

Implement Risk Controls

Part of the process of implementing control measures is to inform personnel in the system of the risk management process results and subsequent decisions. Careful documentation of each step in the risk management process facilitates risk communications.

Some degree of security risk is unavoidable. Your goal is to continuously minimize this risk wherever it is feasible to do so. For example, if it is infeasible to lock a door, it might still be feasible to reduce its attractiveness as an entry point (e.g., better lighting) or to know if unauthorized entry has occurred (e.g., alarm, door seals).

Thoroughly inspect incoming raw materials and other supplies and document the inspections.

Keep accurate inventories of incoming raw materials and outgoing finished products. Retain samples for reference purposes.

If products can be returned to you, have a written policy describing how the products are to be handled including the steps that are to be taken to keep returned product separate from regular stock

Do all you can to assure the clear identification of the raw materials (including water) used to produce your product and of the finished product itself as it moves through distribution channels (ideally the raw materials and finished product would be identified by batch or lot codes). This will help avoid having your safe products being swept off the market with unsafe products and will help agencies trying to determine where, and the means by which, the attack took place.

Use and regularly change passwords (at least eight characters and preferably incorporating some non-alphabetical characters) for computer systems. Make sure anti-virus software is current.

Make sure that employees identified as responsible for security know the roles and responsibilities of the various food safety agencies in California. See Attachment I - Agency List.

Prepare a written recall plan. See Attachment II - FDA Recall Policies.

Prepare a written evacuation and employee safety plan.

Prepare a written plan for continued operation (e.g., at another facility) if your facility becomes temporarily unusable. Identify alternate sources of raw materials and other supplies (including water).

Make and keep current a list of people and agencies (e.g., local fire and police departments, Food and Drug Branch), including alternates, you may need to quickly

INTERIM GUIDANCE FOR FOOD AND AGRICULTURE SAFETY AND SECURITY

November 2001

contact if an attack occurs involving your facility and the various ways you can contact them (e.g., home and work phones, FAX, E-mail).

Make sure that agencies that may have to respond in an after hours situation (e.g., local Hazardous Materials units) know how to contact you and your employees who are responsible for security. Review facility layout with Hazardous Materials units.

Identify yourself (or select and identify another single employee) to all your employees as being responsible overall for food security issues. Select and identify additional employees to be responsible for parts of your security plan as available and necessary. Be sure to include the selected employees in your security decision-making process and gain their support. These employees should be able at all times during their shifts to know who is, and who should be, at your facility and where. Do not make employees responsible for something they are not able and also authorized to control.

Supervise and Review

Supervision and review process should be systematic and ensure control recommendations have been implemented. In addition, the need for further evaluation of a process due to unanticipated change could result in additional actions. A feedback system is needed to ensure that the corrective or preventive action taken was effective and that any additional corrective action can be implemented as required.

Immediately investigate all reports of suspicious or unusual activity (including missing or excess stock) that might be related to the security of your products or facility. Thoroughly document each investigation in writing. Report any findings of concern to appropriate agencies.

Randomly inspect your facility for compliance with security practices. Hold all employees accountable for understanding and complying with the security practices. Reward employees who report security breaches and weak spots.

Sound security practices will be needed indefinitely. But this does not mean that practices should remain unchanged. Periodically review your practices with the goal of improving security while maintaining or reducing their cost and impact to your facility.

Review the **attached checklist** for suggestions on some specific security practices to consider.

**INTERIM GUIDANCE FOR FOOD AND AGRICULTURE
SAFETY AND SECURITY**

November 2001

CHECKLIST

Restrict or closely supervise entry by unauthorized persons to your facility or to its critical areas. For example:

Provide nighttime illumination and video surveillance of facility grounds, exterior and interior

Use cardlock type systems and warning signs to restrict critical entry areas to authorized persons

Use metal or metal clad exterior doors

Provide locks, seals, sensors or alarms for doors, windows, skylights and other access points to facility and to areas where raw materials, in-process, finished products, food contact surfaces and packaging are kept. If removable key operated locks are used, remove any codes that could be used to make new keys, uniquely mark the lock (to allow detection if the same type of lock is substituted), individually number keys and closely control their issuance. Minimize the number of keys that need to be carried off-premises, especially if new keys can be made, and limit key access to authorized employees.

Minimize or eliminate vehicle access to water sources and other critical areas. Vehicles can carry large amounts of harmful substances.

Improve the security of your vendors and shippers. For example:

Purchase raw materials and other supplies only from known reputable suppliers and vendors

Ship finished product only with known reputable shippers

Use tamper-evident packaging / seals for your products and their shipping containers

Require the employees of suppliers, vendors and shippers who visit your facility to carry and display photo identification

Require suppliers, vendors and shippers to provide you with written assurances about their own security practices (e.g., background checks, photo identification, sealed containers with seal numbers on shipping documents, lot code traceability, product return handling procedures, recall procedures)

**INTERIM GUIDANCE FOR FOOD AND AGRICULTURE
SAFETY AND SECURITY**

November 2001

Screen all new employee applicants (including seasonal, temporary and contract). For example (applicant approval for screening should be obtained during the hiring process):

Obtain references from previous employers

Conduct criminal background checks

Perform drug testing

Closely supervise new employees. For example:

Place new employees on shifts where oversight by senior employees is most likely.

Closely supervise all employees. For example:

Perform random drug testing (check with an attorney to determine how to obtain approval and implement).

Limit employee access to those areas of your facility necessary for the employee's position. Use daily shift specific rosters

Prohibit or restrict personal items (e.g., lunch containers, purses) in facility or in critical facility areas

Provide management owned locks for employee lockers and establish authority to enter lockers randomly for security checks. (Check with an attorney to determine how to obtain approval and implement).

Install metal mesh lockers that permit employee locker contents to be visible.

Issue identification badges with photos and ID numbers. Closely control these badges (e.g., keep unissued badges in a secure location, be sure that persons leaving your employment turn in their badges).

Periodically review your practices. For example

Regularly train employees about your security practices (especially when the practices change) and test their compliance.

Hire security patrols or services (e.g., monitoring video surveillance equipment)

Join one or more industry associations where security ideas and concerns can be shared and discussed.

**INTERIM GUIDANCE FOR FOOD AND AGRICULTURE
SAFETY AND SECURITY**

November 2001

Attachment I – Agency List

**State Agency Contact Information
Food and Agriculture Security**

Immediately Report Information on credible threats to:
Local Law Enforcement Officials and Office of Emergency Services Warning Center (916) 262-1621 and/or
Federal Bureau of Investigation Regional Offices at (916) 481-9110 (Sacramento),
(415) 553-7400 (San Francisco), (858) 564-1255 (San Diego), (310) 996-5000 (Los Angeles)

Suspected Food or Water-Borne Human Health Hazard	Suspected Animal Feed Contamination	Suspected Animal Disease or Infestation That May Threaten Animal Agriculture	Suspected Plant Disease or Infestation That May Threaten Agriculture
<p>Contact local Public Health Office (see telephone directory Government pages – Local or County Health Dept.)</p> <p>Department of Health Services (DHS) Food and Drug Branch (916) 445-2264 DHS DUTY OFFICER (916) 328-3605*</p> <p>DHS Division of Communicable Disease Control (510) 540-2566 Duty Officer (800) 971-9631*</p>	<p>California Department of Food and Agriculture, Inspection Services</p> <p>Headquarters, Sacramento (916) 654-0574</p> <p>Modesto Office (209) 491-9347</p> <p>Fresno Office (559) 452-9687</p> <p>Ontario Office (909) 930-9689</p>	<p>Producers should contact their veterinarian <i>first</i>, then:</p> <p>California Department of Food and Agriculture, Animal Health Branch</p> <p>Headquarters, Sacramento (916) 654-1447 Redding District Office* (530) 225-2140 Modesto District Office* (209) 491-9350 Fresno District Office* (559) 237-1843 Ontario District Office* (909) 947-4462</p> <p>California Animal Health and Food Safety Laboratory System</p> <p>Central Laboratory, Davis (530) 752-8709 Fresno Branch Laboratory (559) 498-7740 San Bernardino Branch Laboratory (909) 383-4287 Tulare Branch Laboratory (559) 688-7543 Turlock Branch Laboratory (209) 634-5837</p>	<p>Contact County Agriculture Commissioners (see telephone directory Government pages) first, then:</p> <p>California Department of Food and Agriculture, Plant Health and Pest Prevention Services</p> <p>Headquarters, Sacramento (916) 654-0317</p> <p>Fresno District Office (559) 445-5472</p> <p>San Jose District Office (408) 254-8573</p> <p>San Diego District Office (619) 698-0211</p> <p>Bell District Office (323) 881-6961</p> <p>Van Nuys District Office (818) 901-0719</p> <p>Riverside District Office (909) 782-4190</p> <p>Plant Pest Diagnostics Laboratory (916) 262-1100</p>

* 24 hours a day emergency contact

**INTERIM GUIDANCE FOR FOOD AND AGRICULTURE
SAFETY AND SECURITY**

November 2001

**Federal Agency Contact Information
Food and Agriculture Security**

Immediately Report Information on credible threats to:
Local Law Enforcement Officials and Office of Emergency Services Warning Center (916) 262-1621 and/or
Federal Bureau of Investigation Regional Offices at (916) 481-9110 (Sacramento),
(415) 553-7400 (San Francisco), (858) 564-1255 (San Diego), (310) 996-5000 (Los Angeles)

Suspected Food or Water Borne Human Health Hazard	Suspected Animal Disease or Infestation That May Threaten Animal Agriculture	Suspected Plant Disease or Infestation in Imported or Exported Products That May Threaten Agriculture
<p>Call your Local or County Public Health Office first.</p> <p>U. S. Centers for Disease Control and Prevention (707) 488-7100*</p>	<p>U. S. Department of Agriculture, Animal and Plant Health Inspection Services, Veterinary Services CA/NV Area Office (916) 857-6170 or Toll Free (877) 741-3690*</p>	<p>U. S. Department of Agriculture – Animal and Plant Health Inspection Service Headquarters (916) 857-6241 Smuggling Interdiction Teams Bay Area (650) 821-8664 Imperial Co./San Diego (619) 662-7333 Los Angeles (323) 881-6961</p> <p>Or call your local Port Director (see telephone directory Government pages under U.S. Customs).</p> <p>U.S. Customs (Imported Products) San Diego (619) 671-8920 San Francisco (415) 782-9375</p> <p>U.S. Food and Drug Administration (Exported Products) Division of Emergency Investigation Operations (301) 443-1240*</p>

- 24 hours a day emergency contact

Federal and State Agency Web site Addresses:

California Department of Health Services www.dhs.ca.gov

California Department of Food and Agriculture www.cdfa.ca.gov

University of California - Animal Health and Food Safety Services Laboratory <http://cahfs.ucdavis.edu/>

U. S. Department of Agriculture - Animal and Plant Health Inspection Services www.usda.aphis.gov

U.S. Food and Drug Administration www.fda.gov

U. S. Centers for Disease Control and Prevention www.cdc.gov

**INTERIM GUIDANCE FOR FOOD AND AGRICULTURE
SAFETY AND SECURITY**

November 2001

Attachment II – FDA Recall Policies

**U.S. Food and Drug Administration
Center for Food Safety and Applied Nutrition
Industry Affairs Staff Brochure
August 2000**

FDA Recall Policies

The recall of a defective or possibly harmful consumer product often is highly publicized in newspapers and on news broadcasts. This is especially true when a recall involves foods, drugs, cosmetics, medical devices, and other products regulated by FDA.

Despite this publicity, FDA's role in conducting a recall often is misunderstood not only by consumers, but also by the news media, and occasionally even by the regulated industry. The following headlines, which appeared in two major daily newspapers, are good examples of that misunderstanding: "FDA Orders Peanut Butter Recall," and "FDA Orders 6,500 Cases of Red-Dyed Mints Recalled." The headlines are wrong in indicating that the Agency can "order" a recall. FDA has no authority under the Federal Food, Drug, and Cosmetic Act* to order a recall, although it can request a firm to recall a product.

Most recalls of products regulated by FDA are carried out voluntarily by the manufacturers or distributors of the product. In some instances, a company discovers that one of its products is defective and recalls it entirely on its own. In others, FDA informs a company of findings that one of its products is defective and suggests or requests a recall. Usually, the company will comply; if it does not, then FDA can seek a court order authorizing the Federal Government to seize the product.

This cooperation between FDA and its regulated industries has proven over the years to be the quickest and most reliable method to remove potentially dangerous products from the market. This method has been successful because it is in the interest of FDA, as well as industry, to get unsafe and defective products out of consumer hands as soon as possible.

FDA has guidelines for companies to follow in recalling defective products that fall under the Agency's jurisdiction. These guidelines make clear that FDA expects these firms to take full responsibility for product recalls, including follow-up checks to assure that recalls are successful.

Under the guidelines, companies are expected to notify FDA when recalls are started, to make progress reports to FDA on recalls, and to undertake recalls when asked to do so by the Agency.

The guidelines also call on manufacturers and distributors to develop contingency plans for product recalls that can be put into effect if and when needed. FDA's role under the guidelines is to monitor company recalls and assess the adequacy of a firm's action. After a recall is completed, FDA makes sure that the product is destroyed or suitably reconditioned and investigates why the product was defective.

The guidelines categorize all recalls into one of three classes according to the level of hazard involved. **Class I** recalls are for dangerous or defective products that predictably could cause serious health problems or death. Examples of products that could fall into this category are a food found to contain botulinal toxin, a label mix-up on a lifesaving drug, or a defective artificial heart valve.

Class II recalls are for products that might cause a temporary health problem, or pose only a slight threat of a serious nature. One example is a drug that is understrength but that is not used to treat life-threatening situations.

**INTERIM GUIDANCE FOR FOOD AND AGRICULTURE
SAFETY AND SECURITY**

November 2001

Class III recalls are for products that are unlikely to cause any adverse health reaction, but that violate FDA regulations. An example might be bottles of aspirin that contains 90 tablets instead of the 100 stated on the label.

FDA develops a strategy for each individual recall that sets forth how extensively it will check on a company's performance in recalling the product in question. For a Class I recall, for example, FDA would check to make sure that each defective product has been recalled or reconditioned. In contrast, for a Class III recall the Agency may decide that it only needs to spot check to make sure the product is off the market.

Even though the firm recalling the product may issue a press release, FDA seeks publicity about a recall only when it believes the public needs to be alerted about a serious hazard. For example, if a canned food product, purchased by a consumer at a retail store, is found by FDA to contain botulinal toxin, an effort would be made to retrieve all the cans in circulation, including those in the hands of consumers. As part of this effort the Agency also could issue a public warning via the news media to alert as many consumers as possible to the potential hazard.

FDA also issues general information about all new recalls it is monitoring through a weekly publication titled "FDA Enforcement Report" which is available by subscription from the Superintendent of Documents, Government Printing Office. For price and ordering information, contact the Government Printing Office, Washington, DC 20402, Telephone 202-512-1800; or fax to 202-512-2233. The latest issues of the FDA Enforcement Report are available on FDA's Internet Website

www.fda.gov/opacom/enforce.html

For additional information on recalls, contact the [FDA District Office](#) nearest you.

* Sec. 412 and Sec. 518 Food Drug and Cosmetic Act.; Sec. 351 Public Health Service Act.

Food Safety Notice

Guidelines for Food Safety During Temporary Power Outages

This Food Safety Notice is being issued by the Department of Health Services' Food and Drug Branch on behalf of the California Food Safety Task Force to provide guidance to the retail food industry. It was developed through the collaborative efforts of the Retail Food Industry, food safety experts at the University of California at Davis, the California Conference of Directors of Environmental Health, California Conference of Local Health Officers, and the California Department of Health Services.

California is experiencing an electrical power crisis that may result in random, unscheduled power outages. Appropriate decision-making before, during, and immediately after power outages is necessary to protect consumers from unsafe food and minimize product loss. The Department recommends that food retailers develop a plan and obtain appropriate emergency supplies before the need arises.

The food items of concern are those that are potentially hazardous foods (PHF). Generally, PHF are moist, perishable foods in and on which bacteria can grow most easily during the time when the food is held in the temperature danger zone (41°F to 140°F).

A POWER OUTAGE OF 2 HOURS OR LESS IS NOT CONSIDERED HAZARDOUS TO FOOD THAT IS HELD UNDER SAFE CONDITIONS WHEN THE OUTAGE BEGINS.

WHEN THERE IS A POWER OUTAGE...

- ❑ Note the time at which the power outage begins.
- ❑ Discard food products that are in the process of being cooked, but which have not yet reached the final temperature.

ACTIONS THAT CAN KEEP FOOD SAFE FOR SEVERAL HOURS

Cold Potentially Hazardous Foods

- ❑ Keep refrigerator and freezer doors closed as much as possible
- ❑ If practical, group packages of cold food together to reduce heat gain
- ❑ Cover open refrigerated and frozen food cases, especially vertical displays
- ❑ *Caution: The use of dry ice may result in unsafe build-up of CO₂ (Carbon Dioxide).*

Hot Potentially Hazardous Foods

- ❑ Do not place hot foods in refrigerators or freezers
- ❑ Use "canned heat" under foods on electric steam tables to help maintain PHF at 140°F
- ❑ Use ice and/or ice baths to rapidly cool small batches of hot food

Food Safety Notice

DISCONTINUE FOOD PREPARATION IF ANY OF THE FOLLOWING CONDITIONS EXIST

- ❑ Inability to properly wash, rinse and sanitize utensils
- ❑ Inoperative hood ventilation and make-up air supply systems in conjunction with gas or solid fuel heating and cooking equipment
(Danger: Toxic fumes may cause injury or death)
- ❑ Lack of sufficient light in food preparation areas to allow for safe food preparation and cleaning and sanitizing of food contact surfaces.
- ❑ No hot water, inadequate water pressure
- ❑ Unsafe food temperatures (See tables below)

WHEN THE POWER IS RESTORED

- ❑ Identify PHF that may have been in the temperature danger zone
- ❑ Check the internal food temperature
- ❑ If practical, separate packages of food in refrigeration units and freezers to allow for faster re-cooling.

Use the following to determine the disposition of PHF:

REFRIGERATED PHF

Use the table below as a guide for handling PHF stored in refrigeration units during power outages:

Duration of Power Outage (hours)	Food Temperatures		
	45° F or below	46°F to 50°F	50°F or above
0-2	PHF can be sold	Immediately cool PHF to 45°F or below within 2 hours	PHF cannot be sold
2-3	PHF can be sold, but must be cooled to 41°F or below within 2 hours	Immediately cool PHF to 45°F or below within 1 hour.	
4+	Immediately cool PHF to 41°F or below within 1 hour	PHF cannot be sold	

PHF IN HOT HOLDING UNITS

Use the following table to determine what to do with PHF that is held in hot holding units and is below 140°F at the time the power is restored:

Duration of Power Outage	Food below 140°F in Hot Holding Units When Power is Restored
2 hours or less	1. May be sold if reheated to 165° F and then held at 140° F or above; or 2. May be sold if rapidly cooled to 41 ° F or below within 2 hours following restoration of power.
More than 2 hours	Cannot be sold

If food cannot be rapidly cooled as specified in the tables above, it cannot be sold.

Food Safety Notice

REOPENING

If you voluntarily closed your facility, the following conditions should be verified prior to resuming food preparation and/or sale of potentially hazardous foods:

1. All unsafe potentially hazardous food has been discarded
 - If there are any questions regarding the safety of specific foods, contact your local environmental health agency
2. Electricity and gas services have been restored
3. All circuit breakers have been properly reset as needed
4. All equipment and facilities are operating properly, including:
 - Lighting
 - Refrigeration
 - Hot holding
 - Ventilation
 - Toilet facilities
5. Hot (minimum 120° F) and cold potable water, under pressure for:
 - Hand washing
 - Proper dishwashing

If your facility was closed by a local environmental health agency, it must remain closed until you obtain official approval from that agency to reopen.

DISPOSAL OF FOOD

- **PHF that has been subjected to unsafe temperatures prior to the power outage might not be safe to eat even if the procedures in the tables on the previous page are followed. WHEN IN DOUBT, THROW IT OUT!**
- If it is determined that food must be discarded, document the type and amount of food and the reason for disposal for insurance and regulatory purposes.
- Small volumes of food to be discarded can be denatured with a cleaning product (such as bleach) and placed in the outside refuse bin.
- To discard large volumes of food, contact your refuse disposal company or your local landfill operator for disposal instructions.
- If there are any questions regarding the safety of specific foods, contact your local environmental health agency.

LOCAL ENVIRONMENTAL HEALTH AGENCY

This document may serve as a guideline for most situations encountered during power outages. The local environmental health agency is primarily responsible for enforcing the California Uniform Retail Food Facilities Law, and shall determine appropriate actions to be taken based on local conditions.

GUIDANCE FOR FOODS EXPOSED TO AMMONIA LEAKS IN COLD STORAGE FACILITIES

Worker Health and Safety – First and foremost, managers and supervisors must **ensure the safety of employees** following an ammonia leak. Employees should be evacuated from the immediate area until an assessment by trained hazardous material responders determines that it is safe to allow employees to return to the area. Ammonia [NH₃] has significant toxicity at reasonably low levels. Children, pregnant women, and nursing mothers are likely to be especially sensitive. Symptoms indicative of ammonia toxicity include nausea, vomiting, dizziness and/or difficulty breathing, mucous membrane irritation. Anyone experiencing any of these symptoms following an ammonia leak should seek immediate medical attention. NIOSH and OSHA have established that ammonia levels may not exceed 50 ppm during an 8 hour workplace period, and EPA has established recommended criteria for risk management of ammonia. For specific information dealing with worker health and safety issues in ammonia leaks, see the attached references.

Illnesses and Outbreaks Related to Ammonia in Foods - Illnesses associated with ammonia-contaminated foods have been reported. In Wisconsin, [*MMWR* v.35, p. 274-5, (May, 1986)], at least 520 cartons of ammonia-contaminated milk were ingested, causing 20 children to experience nausea, stomachache, and sore mouth and throat. This milk was determined to have from 530 to ~1,520 ppm of ammonia contamination. In Illinois, 157 students and teachers became ill, with 42 children and 2 adults being sent to emergency rooms via 18 ambulances due to ammonia exposure from contaminated chicken tenders in a school lunch program. Ammonia levels in these chicken tenders were estimated at 552 to 2468 ppm while uncooked [still frozen] and 880 to 1076 ppm in unserved heated chicken pieces. [*J Food Protection*, v.67, p. 1299-1302. (June, 2004)]

Assessing the Safety of Foods Exposed to Ammonia – Firms experiencing an ammonia leak in a cold storage warehouse should contact the California Department of Health Services - Food and Drug Branch (FDB) after the safety of the employees has been established (see contact number below). Occasionally, firms experiencing an ammonia leak may wish to attempt to salvage or recondition foods exposed to ammonia instead of destroying and disposing of the exposed food. While there are no current regulatory limits for the amount of ammonia in foods, the FDB strongly suggests that firms use caution in any attempt to salvage or recondition these foods. The responsibility for ensuring the safety of the food rests with the owner of the food. FDB offers the following guidance for firms that wish to assess the safety of foods exposed to ammonia for the purpose of salvaging or reconditioning.

- Firms should develop a written proposal for evaluation of salvaging or reconditioning foods exposed to ammonia. The proposal will be evaluated by FDB staff and should include:
 - A thorough description of the event with times, dates, amounts and types of foods by size and packaging, and any measured levels of ammonia to date.
 - A detailed sampling and testing plan for all foods exposed to the ammonia, and identification of an experienced food laboratory that will conduct product analysis. This plan should include sufficient sample sizes for each product type and packaging to allow for a reasonable degree of comfort with the analytical findings. The plan should also include sufficient testing of similar non ammonia-exposed foods to determine “normal” or “background” levels in these food products. Although there are no strict requirements for the tests to be conducted, the plan should, at a minimum, include ammoniacal nitrogen testing and may include all three assessments described in the paper by Goodfellow referenced below (an organoleptic evaluation, a pH assessment, and ammoniacal nitrogen testing).

FDB will evaluate the plan and provide feedback on any changes needed. Any plan subsequently approved by FDB would require strict oversight and control of all exposed foods at all times by the firm. It is likely that an embargo will be placed on all exposed foods until a decision is reached on the appropriate disposition or handling of these foods. Once an embargo is placed, no exposed foods can be removed from the facility without approval by FDB. Violation of an embargo can result in civil or criminal penalties.

California Department of Health Services – Food and Drug Branch contact information

916-650-6500

LIST OF AMMONIA REFERENCES

NIOSH Pocket Guide for Ammonia: <http://www.cdc.gov/niosh/npg/npgd0028.html> [listing **OSHA PEL mandated limit**: TWA 50 ppm (35 mg/m³)] .

OSHA's NH₃ Refrigeration–Safety-Health Topics:
http://www.osha.gov/SLTC/etools/ammonia_refrigeration/index.html

OSHA's Ammonia Refrigeration e-Tool: http://www.osha.gov/SLTC/etools/ammonia_refrigeration/index.html

NH₃-Release/Hazards-[EPA]
[http://yosemite.epa.gov/oswer/ceppoweb.nsf/vwResourcesByFilename/ammonia.pdf/\\$file/ammonia.pdf?OpenElement](http://yosemite.epa.gov/oswer/ceppoweb.nsf/vwResourcesByFilename/ammonia.pdf/$file/ammonia.pdf?OpenElement)

EPA Ammonia Management pdf file: <http://www.epa.gov/ttn/oarpg/t3/memoranda/ammon.pdf>

EPA NH₃ Management Program; <http://www.epa.gov/swercepp/pubs/plan/ammonia/brochure.htm>

Goodfellow, S.J., Assuring Quality After Ammonia Leaks, Food Product Development, October 1978, p. 32.

Smith, M.A., Ammonia Spills and the Effect of Ammonia on Products Stored in Refrigerated Warehouses – Project #87-3, August 1987, Sponsored by The Refrigeration Research Foundation.